

The background is a solid orange color. Overlaid on this are several white, thin, geometric lines that form a complex, abstract pattern. These lines include straight lines, curved lines, and shapes that resemble perspective drawings of rectangles or trapezoids, creating a sense of depth and movement.

***Altium***

# RIGID-FLEX PCB DESIGN

A GUIDE BOOK FOR DESIGNERS

---

**By Ben Jordan**

Editors: Max Clemons, Ben Jordan

# TABLE OF CONTENTS

<b>Foreword</b>	<b>3</b>	<b>Application Examples of Rigid Flex PCBs</b>	<b>25</b>
<b>Introduction</b>	<b>4</b>	Dynamic Flex Ideas	25
<b>Flex-Circuit Materials</b>	<b>5</b>	Static Flex Applications	27
Substrate and Coverlay Films	5	Fab Considerations	29
Conductors	6	<b>Multi-Layer Rigid-Flex</b>	<b>31</b>
Adhesives	7	How to maintain flexibility and lifespan with multiple flex layers	31
Single Layer Flex Circuits	7	Bookbinder Construction	32
<b>Flex &amp; Rigid-Flex Fabrication Processes</b>	<b>9</b>	Staggered Flexible Layer Bands	33
Flex build-ups	9	Getting Ultra-tight bends without sacrificing layer count	33
Flex Fab Steps	9	Single Many-Layer Flex	34
Lamination and Routing	12	Flex Circuit Follies	34
Physical Constraints	14	<b>Conclusion</b>	<b>35</b>
<b>Fab Documentation for Flex Circuits and Rigid-Flex Boards</b>	<b>16</b>	<b>Bibliography</b>	<b>36</b>
Documentation	16	<b>Additional Resources</b>	<b>37</b>
<b>Dos and Don'ts of Flex Circuit Design</b>	<b>20</b>	<b>Glossary</b>	<b>38</b>
Do Keep Flex Flexible	20		
Don't Bend at Corners	21		
Do Use Curved Traces	21		
Don't Abruptly Change Widths	21		
Do Add Support for Pads	22		
Allow for Squeeze-Out	23		
Double-Sided Flex Routing	23		
Do use Hatched Polygons	23		
Via Placement	24		
Defining Flex Cutouts and Corners	24		

# FOREWORD

The past year or two have been very challenging in the printed circuit board industry. Engineering managers, vice-presidents of operations and other functional managers are constantly frustrated with sales and engineering trade-offs. Designers need tighter, higher density boards to keep up with customer demand.

The printed circuit board is becoming more intricate in the overall product solution. This is because of pressure to do higher speed designs such as DDR3/4 and denser, lower power devices.

Sierra has seen it's fair share of these challenges, having focussed on quick-turn prototypes for high-tech / HDI / and rigid-flex PCBs, and being a one-stop shop for helping electronics companies debug their prototypes through our fab, assembly, component procurement processes. This is no easy task.

With this operational experience in mind, it is apparent that modern PCB design tools help designers connect the dots efficiently, but for most packages there's very little manufacturing knowledge built into the tool. This can make it hard to cleanly hand off the data for fabrication. So it's very important for the designer to work closely with the fab to understand build strategy - ie. how it's going to be built. Whatever the CAD tool used, there is still usually a gap between what the designer creates and what is ready for manufacturing. Even with Design Rule Checks, the fab usually has to call the designer or engineer to clarify issues that affect manufacturability and yield.

This industry needs to close the gap between the designer and the PCB production fab. Fortunately there is Altium. With a renewed focus on getting PCB design done right the first time, and willingness to be open and work with PCB fab and assembly shops like Sierra to make sure that from the outset, we will have what we need to make the circuit to spec without countless call backs.

This Rigid-Flex guide book, and the new design capabilities within Altium Designer's PCB Editor for Rigid-Flex design, reflect a commitment to that openness.

Professional Rigid-flex PCB Manufacturer in China [Https://www.pcbelec.com](https://www.pcbelec.com)

# INTRODUCTION

Rigid-Flex can have many benefits, and many designers are at least considering it today who previously did not have to. More PCB designers are facing higher pressures to build ever more densely populated electronics, and with that comes additional pressure to reduce costs and time in manufacturing. Well, this is really nothing new of course. It's just that the scope of these pressures that the engineer and PCB designer have to respond to is continuously broadening. Rigid-Flex PCB technology offers a solution that is viable for many product designs facing these challenges.

Yet there are aspects of rigid-flex technology which could be pot-holes in the road for newcomers. So it's wise to first understand how flex circuits and rigid-flex boards are actually made. From there we can look at the design issues imposed by the materials used, and the fabrication processes employed by most rigid-flex PCB manufacturers. And from there, we can find a clear path to discover the best practices for rigid-flex PCB design.

This guidebook is my attempt to clearly explain the materials, processes and design issues in a way that will enlighten PCB designers of any level, who have not had a great deal of experience - if any - in designing of flex or rigid-flex circuits. It is based on a collection of blog articles on the subject that were published on the AltiumLive blog pages at <http://blog.live.altium.com> from August through October 2013. Though the blogs were a little bit glib in places, we've done a reasonably good refactoring of the content to make sure it's not missing anything essential - especially for those who have not yet done a rigid-flex PCB design.

My hope is that this guidebook will form a good enough introduction to rigid-flex PCB design that more readers will see the technology within reach for their own design projects, and that a result overall will be increased adoption. And, with increased adoption there should be decreased costs, which in turn will further increase access for more electronic product developers to utilize rigid-flex boards.

Let's begin by looking at rigid-flex circuit materials.

# FLEX-CIRCUIT MATERIALS

## 1.1 Substrate and Coverlay Films

The base material used in most common rigid printed circuit boards is woven fibreglass impregnated in epoxy resin. It's actually a fabric, and although we term these "rigid" if you take a single laminate layer they have a reasonable amount of elasticity. It's the cured epoxy which makes the board more rigid. Because of the use of epoxy resins, they are often referred to as organic rigid printed circuit boards. This is not flexible enough for many applications though for simple assemblies where there's not going to be constant movement it can be suitable.



**Figure 1.1** Flexible Polyimide film. Shinmax Technology Ltd.

*"The most common choice is polyimide, because it's very flexible, very tough, and also incredibly heat resistant."*

For the majority of flex circuit applications, more flexible plastic than the usual network epoxy resin is needed. The most common choice is polyimide, because it's very flexible, very tough (you can't tear or noticeably stretch it by hand, making it tolerant of product assembly processes), and also incredibly heat resistant. This makes it highly tolerant of multiple solder reflow cycles, and reasonably stable in expansion and contraction due to temperature fluctuations. For the majority of flex circuit applications, more flexible plastic than the usual network epoxy resin is needed.

Polyester (PET) is another commonly used flex-circuit material, but it's not tolerant enough of high temperatures to survive soldering. I have seen this used in very low cost electronics where the flexible part had printed conductors (where the PET could not handle the heat of lamination), and needless to say nothing was soldered to it - rather, contact was made by crude pressure with an Anisotropic conductive elastomer.



Anisotropic Elastomers allow conduction vertically but not horizontally.

Anisotropic Elastomers allow conduction vertically but not horizontally.

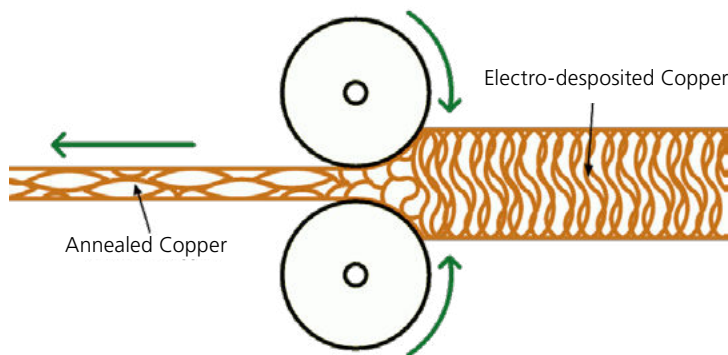
The display in the product in question (a clock radio) never really worked too well due to the low quality of the flex circuit connection. So for rigid-flex we'll assume we're sticking to the PI film. (Other materials are available but not often used).

PI and PET films, as well as thin flexible-epoxy-and-glass-fibre cores, form common substrates for flex circuits. The circuits must then use additional films (usually PI or PET, sometimes flexible solder mask ink) for coverlay. Coverlay insulates the outer surface conductors and protects from corrosion and damage, in the same way solder mask does on the rigid board. Thicknesses of PI and PET films range from 1/3 mil to 3 mils, with 1 or 2 mils being typical. Glass fibre and epoxy substrates are sensibly thicker, ranging from 2 mils to 4 mils.

### 1.2 Conductors

While the above-mentioned cheap electronics may use printed conductors - usually some kind of carbon film or silver based ink - copper is the most typical conductor of choice. Depending upon the application different forms of copper need to be considered. If you are simply using the flexible part of the circuit to reduce manufacturing time and costs by removing cabling and connectors, then the usual laminated copper foil (Electro-Deposited, or ED) for rigid board use is fine. This may also be used where heavier copper weights are desired to keep high-current carrying conductors to the minimum viable width, as in planar inductors.

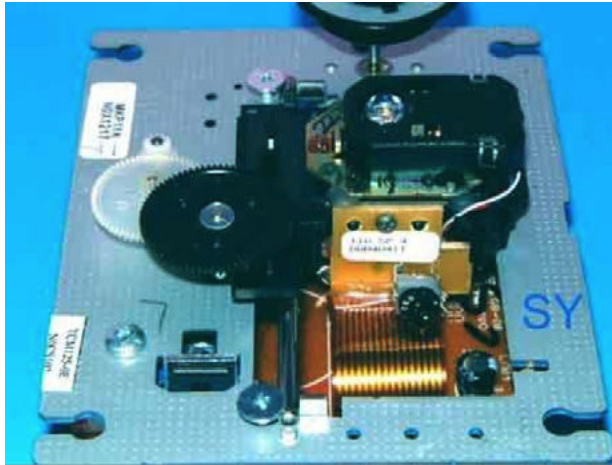
But copper is also infamous for work-hardening and fatigue. If your final application involves repeated creasing or movement of the flex circuit you need to consider higher-grade Rolled Annealed (RA) foils. Obviously the added step of annealing the foil adds



**Figure 1.2** Exaggerated illustration of the annealing process, obviously not to scale. The copper foil passes between high-pressure rollers which elongate the grain structure in a planar orientation, making the copper much more flexible and springy in the normal.

to the cost considerably. But the annealed copper is able to stretch more before fatigue cracking occurs, and is springier in the Z deflection direction - exactly what you want for a flex circuit that will be bending or rolling all the time. This is because the rolling annealing process elongates the grain structure in the planar direction.

Examples of such an application would be gantry connections to a CNC router head, or laser pickup for a Blu-Ray drive (Figure1.3).



**Figure 1.3** Flex-circuit used to link the laser pickup to the main board assembly in a Blu-Ray mechanism. Notice that the PCB on the laser head has the flexible portion bent at right angles, and an adhesive bead has been added for strengthening the flex circuit at the joint (source: Zhuhai Smartech Electronics & Machinery).

### 1.3 Adhesives

Traditionally, adhesives are required for bonding the copper foil to PI (or other) films, because unlike a typical FR-4 rigid board, there's less "tooth" in the annealed copper, and heat & pressure alone are not enough to form a reliable bond. Manufacturers such as DuPont offer pre-laminated single- and double-sided copper clad films for flexible circuit etching, using acrylic or epoxy based adhesives with typical thicknesses of ½ and 1 mil. The adhesives are specially developed for flexibility.

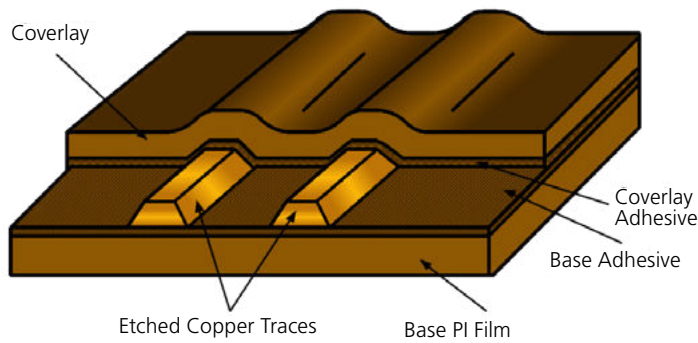
"Adhesiveless" laminates are becoming more prevalent due to newer processes that involve copper plating or deposition directly onto the PI film. These films are chosen when finer pitches and smaller vias are needed as in HDI circuits.

Silicones, hot-melt glues, and epoxy resins are also used when protective beads are added to the flex-to-rigid joins or interfaces (i.e. where the flexible part of the layer stack leaves the rigid part). These offer mechanical reinforcement to the fulcrum of the flex-to-rigid joint which otherwise would rapidly fatigue and crack or tear in repeated use. An example of this is shown in [Figure 1.3](#) above.

### 1.4 Single Layer Flex Circuits

An example of a typical single layer flex circuit cutaway view is illustrated in [Figure 1.4](#). This is the same construction used for most common off-the-shelf FFC (Flexible Flat Connector) cables, which are an alternative to using rigid-flex PCBs where the FFC connectors can be accommodated and cost is the primary driving factor in design decisions. In single-layer flex circuits the copper is pre-laminated on to the PI film by the material vendor, then etched and drilled with a rigid backing plate, and laminated finally with adhesive-based Polyimide coverlay that is pre-punched to expose the copper pads. The adhesives used in this arrangement for coverlay can squeeze out in the process, so it needs to be accommodated by enlarging the pads exposed areas. More will be discussed on this in Chapter 4.

It's important to be aware of the materials used in flexible and rigid-flex circuits. Even though you may generally allow the fabricator freedom to select the materials based on your application, ignorance will not protect you from field-failures of the final product. A really good resource which contains far more detail than the brief introduction here is Coombs, C. F. (Editor, 2008) *The Printed Circuits Handbook, 6th Ed. 2008 McGraw Hill*, pp 61.3 0 - 61.24.



**Figure 1.4** Typical single-layer Flex Circuit stack-up

Knowing the material properties will also help in the mechanical design, evaluation and test of your product. If you are working on automotive products for instance; heat, moisture, chemicals, shock & vibe - all need to be modelled with accurate material properties to determine the product's reliability, and minimum allowed bending radius. The irony is that the driving needs that cause you to choose flexible and rigid-flex are often tied to harsh environments. For example, low-cost consumer personal electronic devices are often subjected to vibrations, dropping, sweat and worse.



# FLEX & RIGID-FLEX FABRICATION PROCESSES

## 2.1 Flex build-ups

At first glance, a typical flex, or rigid-flex board, looks straightforward. However the nature of these requires several additional steps in the build-up process. The beginning of any rigid flex board is always the single or double-sided flex layers. The fabricator may begin with pre-laminated flex with foil, or may begin with unclad PI film, and then laminate or plate up the copper for the initial cladding. Laminating the film requires a thin layer of adhesive, whereas adhesiveless cladding requires a “seed” layer of copper. This seed layer is initially planted using vapor deposition techniques (i.e. sputtering), and provides the key to which chemically deposited copper is plated upon. This one or two-sided flex circuit is drilled, plated through, and etched in much the same steps as typical 2-sided cores in rigid boards.

“The fabricator may begin with pre-laminated flex with foil, or may begin with unclad PI film and then laminate or plate up the copper for the initial cladding.”

## 2.2 Flex Fab Steps

The steps below show Flex-Circuit creation for a typical double-sided flex circuit.

### Adhesive/Seed coating applied

Either an epoxy or acrylic adhesive is applied, or sputtering is used to create a thin copper layer for a plating key.



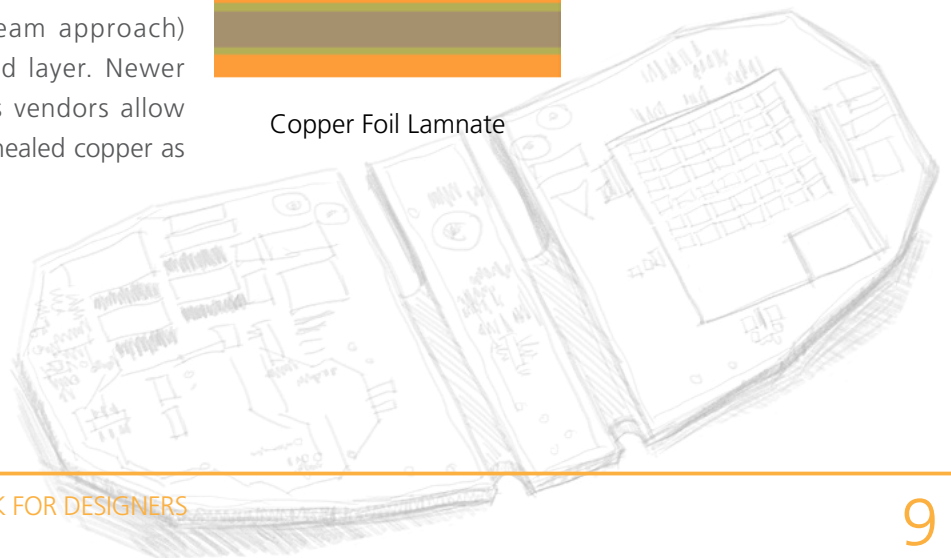
Adhesive Coating

### Copper foil added

Copper foil is added, either by lamination to the adhesive (the more mainstream approach) or chemical plating onto the seed layer. Newer fabrication processes by materials vendors allow adhesiveless lamination of rolled annealed copper as an alternative.



Copper Foil Laminate



**Drilling**

Holes to vias and pads are most often mechanically drilled. Multiple plated flex substrates can be drilled simultaneously by combining them from multiple reels on drums, drilling between work plates, then rolling out to separate reels on the other side of the drilling machine. Pre-cut flex panels can be combined and drilled between rigid blanks in the same way rigid cores are drilled as well, though it requires more careful registration and the alignment accuracy is reduced. For ultra-small holes, laser drilling is available, though at much added cost because each film has to be drilled separately. This would use Excimer (ultraviolet) or YAG (Infrared) lasers for higher accuracy (microvias), and CO2 lasers for medium holes (4+ mils). Large holes and cutouts are punched, but this is a separate process step.



Drilling:  
(Mech. Laser or etch)

**Through-hole plating**

Once the holes are made, copper is deposited and chemically plated in the same way as rigid PCB cores (commonly referred to as Cuposit). Through-hole plating in flex circuits is recommended to be at least 1 mil in plating thickness to add mechanical support to the pad or via, whereas a typical low-cost rigid PCB may only have 1/2 mil cuposit.



Through-Hole Plating

**Etch-resist printing**

Photosensitive etch resist is coated onto the film surfaces, and the desired mask pattern is used to expose and develop the resist prior to chemical etching of the copper.



Etch-Resist

**Etching and stripping**

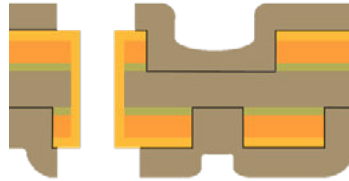
After exposed copper is etched, the etch resist is chemically stripped from the flex circuit.



Etching & Stripping

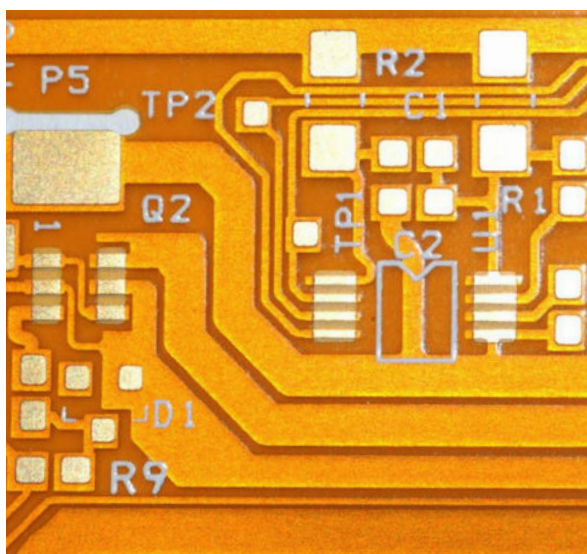
**Coverlay or Covercoat**

Top and bottom areas of the flex circuit are protected by coverlay layers which are cut to shape. There may be components actually mounted on sections of the flexible circuit, in which case the coverlay is also acting as a solder mask. The most common coverlay material is additional polyimide film with adhesive, though adhesiveless processes are available. In the adhesiveless process, photoimageable solder mask (the same as used on rigid board sections) is used, essentially printing the coverlay onto the flex circuit. For coarser cheaper designs screen printing is also an option with final curing of this covercoat film by UV exposure. Basically, the difference is that coverlay is a laminated film, whereas covercoat is an applied material coating which then needs to be cured.



Coverlay:  
Laminated or Printed

Also, cutouts for component or connection pads in the coverlay leave at least two sides of the pad land to anchor under it. You can see this clearly in [Figure 2.1](#).



**Figure 2.1** An example of flex-circuit with Coverlay - notice that the openings in the coverlay are generally smaller than the component pads (source: GC Aero Inc.).

### Cutting out the flex

The final step in creating the flex circuit is cutting it out. This is often referred to as “blanking”. The high-volume cost-effective approach to blanking is by a hydraulic punch and die set (like the one shown in [Figure 2.2](#)), which involves reasonably high tooling costs. However, this method allows punching out of many flex circuits at the same time. For prototype and low-volume runs, a blanking knife is used. The blanking knife is basically a long razor blade, bent into the shape of the flex circuit outline and affixed into a routed slot in a backing board (MDF, plywood or thick plastic such as teflon). The flex circuits are then pressed into the blanking knife to be cut out. For even smaller prototype runs, X/Y cutters (similar to those used in vinyl sign making) could be used.



**Figure 2.2** A blanking die for cutout of Flex Circuits (Source: Haoji Stamping Tool & Die Co.,Ltd.)

## 2.3 Lamination and Routing

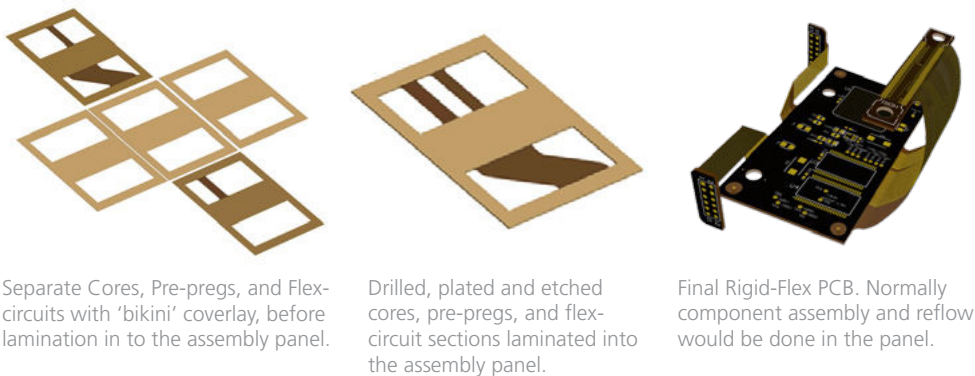
If the flex circuit is to form a part of a rigid/flex combined stack-up (which is what we are interested in), the process doesn’t stop there. We now have a flex circuit that needs to be laminated in between the rigid sections. This is the same as an individual drilled, plated and etched core layer pair, only much thinner and more flexible due to the lack of glass fibre. As noted previously though, a less flexible layer could be made with PI and glass depending on the target application. Because this is being laminated in between rigid sections, it ultimately has to be framed in a panel that mates with the rigid board panel sections as well. Flex circuits that are not being combined with rigid sections are adhered temporarily to a rigid backing board of MDF or FR-4 style materials.

### Laminated Stackups

The flex circuit is laminated into the panel along with the rigid and any other flexible sections, with additional adhesive, heat and pressure. Multiple flex sections are not laminated adjacent to each other unless you are designing multi-layer flex. This generally means each flex section has a maximum copper layer count of 2, so that flexibility is maintained. These flex sections are separated by rigid pre-pregs and cores or PI bonding sheets with epoxy or acrylic adhesives.

Essentially, each rigid panel is separately routed out in the areas where the flex is going to be allowed to, well, flex.

Here is an example process of laminating into a rigid-flex board, with two, 2-layer flex circuits embedded between three rigid sections. The layer stack up would look like that shown in Figures 2.3 & 2.4.

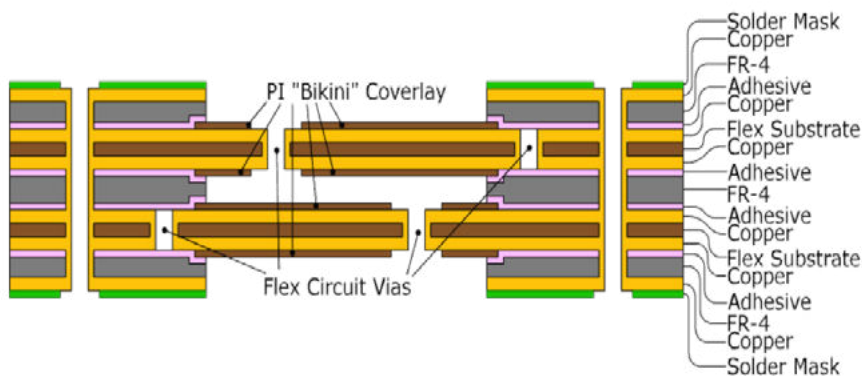


Separate Cores, Pre-pregs, and Flex-circuits with 'bikini' coverlay, before lamination in to the assembly panel.

Drilled, plated and etched cores, pre-pregs, and flex-circuit sections laminated into the assembly panel.

Final Rigid-Flex PCB. Normally component assembly and reflow would be done in the panel.

**Figure 2.3** How the Etched, plated, coverlayered and blanked flex panels are combined with the glass-epoxy rigid panels.



**Figure 2.4** Detailed Stack Diagram including plated-through holes for each flex section, as well as final through-plated holes in the rigid section.

In the example stack up shown in Figure 2.4, we have two pre-etched and cut flex circuits, each double sided and plated through. The flex circuit has been blanked into a final assembly panel including borders for framing - this will keep the flex circuit flat during final assembly after lamination with the rigid panel sections. There are certainly some potential hazards with inadequate support of flex circuit elbows and large open sections during assembly - especially in the heat of a reflow oven.

While this example does show adhesive layers it's important to note that many designers are shying away from using adhesives, due to unacceptable z-axis expansion in reflow. However FR-4 prepreg and thermosetting epoxies effectively achieve the desired result and are for all intents and purposes here considered 'adhesive' layers. Additional adhesion can be achieved through treatment of the copper on the flex layers to improve the 'tooth' into the laminated prepregs. Adhesiveless double-sided flex laminates are shown here. These are entirely polyimide film with a bondable polyimide coating which the copper foil is bonded to. DuPont™ Pyralux® and Rogers Corp. R/Flex® are examples of popular adhesiveless laminates.

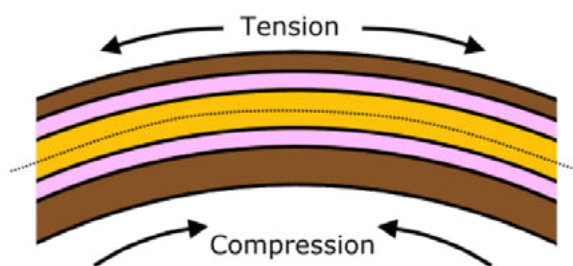
The coverlay is also applied - like stickers laminated on with adhesive, or by a photo-printing process as mentioned earlier. Once the final flex and rigid panels in this 6-layer stackup are placed together, they are laminated with the outermost (top and bottom) final copper foil layers. Then another drilling for top-to-bottom plated through holes is done. Optionally, laser drilled blind vias (top to first flex, bottom to last flex) could also be made, again adding expense to the design. The holes are plated through from top to bottom, and blind vias if there are any, and the final outer layer copper patterns are etched. The final steps are the printing of the top and bottom solder mask, top and bottom silkscreen and preservative plating (such as ENIG) or hot air leveling (HASL).

Careful attention needs to be paid to layer pair planning and documentation for drilling and through-hole plating, because blind vias from a rigid surface layer down to an opposing flex-circuit layer will have to be back-drilled and add significant cost and lower yield to the fab process.

## 2.4 Physical Constraints

### Multiple Flex Sub-Stacks

While it's possible to build just about any stack-up with rigid and flex sections, it can get ridiculously expensive if you're not careful to consider the production steps and the material properties involved. One important aspect of flex circuits to remember is the stresses within the materials occurring as the circuit bends. Copper, being a non-ferrous metal, is known to suffer work-hardening, and fatigue fractures will occur eventually with repeated flex cycling and tight radii. One way to mitigate this is to only use single-layer flex circuits, in which case the copper resides at the center of the median bend radius and therefore the film substrate and coverlay are in the greatest compression and tension, as shown in Figure 2.5. Since the Polyimide is very elastic this is not a problem, and will last much longer under repeated movement than multiple copper layers will.



**Figure 2.5** For highly repetitive bending circuits, it's best to use RA copper in single-layer flex to increase the fatigue life (in cycles before failure) of the copper in the circuit.

Along the same lines, having multiple separate flex circuits is often necessary, but it's best to avoid having bends at overlapping sections where the length of the flex sections limits the bend radius.

### Adhesive Beads

There are times when you need to consider using strengtheners where the flex circuit exits the rigid board. Adding a bead of epoxy, acrylic or hot-melt will help improve the longevity of the assembly. But dispensing these liquids and curing them can add

laborious steps to the production process, increasing cost. As always with PCB design, there are trade-offs.

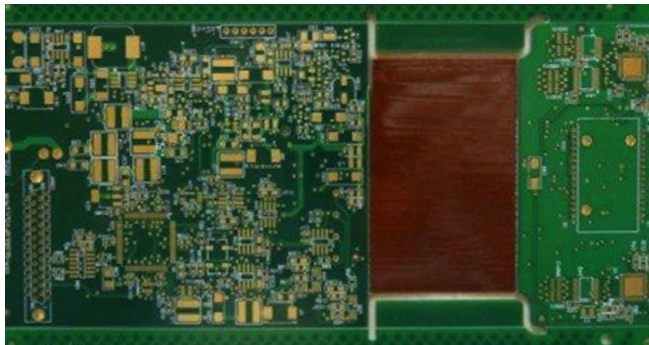
Automated fluid dispensing can be used, but you need to be really careful to collaborate with the assembly engineers to make sure you don't end up with globs of glue dripping under the assembly. In some instances the glue must be applied by hand which adds time and cost. Either way, you need to provide clear documentation for the fabrication and assembly folks.

### **Stiffeners & Terminations**

Extreme ends of flex circuits typically terminate to a connector if not to the main rigid board assembly. In these cases, the termination can have a stiffener applied (more thick Polyimide with adhesive, or FR-4). Generally then, it's convenient to leave the ends of the flex embedded within the rigid-flex sections as well.

### **The Panel**

The rigid flex circuit stays together in its panel for the assembly process, so components can be placed and soldered on to the rigid terminations. Some products require components to be mounted also on flex in some areas, in which case the panel has to be put together with additional rigid areas to support the flex during assembly. These areas are not adhered to the flex and are routed out with a controlled-depth router bit (with "mouse-bites") and finally punched out by hand after assembly.



**Figure 2.6** Final Rigid-Flex panel example. Notice that this one has front and back board edges, and flex circuit, routed out. The rigid sides are V-grooved for snapping off later. This will save time in assembly into the enclosure (source: YYUXING Shenzhen Electronics Co., LTD.)



# FAB DOCUMENTATION FOR FLEX CIRCUITS AND RIGID-FLEX BOARDS

## 3.1 Documentation

This is essentially where we tell the fabricator what we want, and it's probably the most likely part of the process where errors or misunderstandings can make costly delays and waste happen. Fortunately there are standards we can reference to make sure we are communicating clearly to the fabricator, in particular IPC-2223.

It could boil down to a few golden rules:

1. Make sure your fabricator is capable of building your rigid-flex design.
2. Make sure they collaborate with you on designing your layer stack to fit their particular processes.
3. Use IPC-2223 as your point of reference for design, making sure the fabricator uses the same & related IPC standards - so they are using the same terminology as you.
4. Involve them as early as possible in the process.

“ODB++ v7.0 or later is preferred, since it has specific layer types added to the job matrix that enable clear flex-circuit document for GenFlex® and similar CAM tools.”

### Output Data Set

In interviewing a handful of rigid-flex capable board houses locally, we found that many designers still present gerber files to the board house. However ODB++ v7.0 or later is preferred, since it has specific layer types added to the job matrix that enable clear flex-circuit documentation for GenFlex® and similar CAM tools. Additionally ODB++ provides complete data sets for bare-board and in-circuit testing. A subset of the data included is shown in table 1.

Layer Type	Base Type	Description
Coverlay	solder_mask	Clearances of a coverlay layer
Covercoat	solder_mask	Clearances of a covercoat layer
Punch	route	Pattern for die-punching of the flex circuit
Stiffener	mask	Shapes and locations of stiffeners to be adhered
Bend Area	mask	Labelling of areas that will be bent while in use
PSA	mask	Pressure Sensitive Adhesive shapes and locations
Area	document	An area definition (Rigid, Flex, or arbitrary)

**Table 1** Subset of Layer Types in ODB++ (v7.0 and later) used for GenFlex  
(Source: ODB++ v7.0 Specification)



Layer Type	Base Type	Description
Exposed Area	document	An exposed area of an inner layer and it's associated coverlay (could also be used for embedded components)
Signal Flex	signal	A signal layer for a flex circuit
Power Ground Flex	pg	A power or ground layer for a flex circuit
Mixed Flex	mixed	Mixed layer for a flex circuit
Plating_mask	mask	A mask for defining which areas within a layer should be masked off from plating process
Immersion_Mask	mask	A mask for defining which areas within a layer should be masked off for immersion gold

**Table 1** Subset of Layer Types in ODB++ (v7.0 and later) used for GenFlex  
 (Source: ODB++ v7.0 Specification)

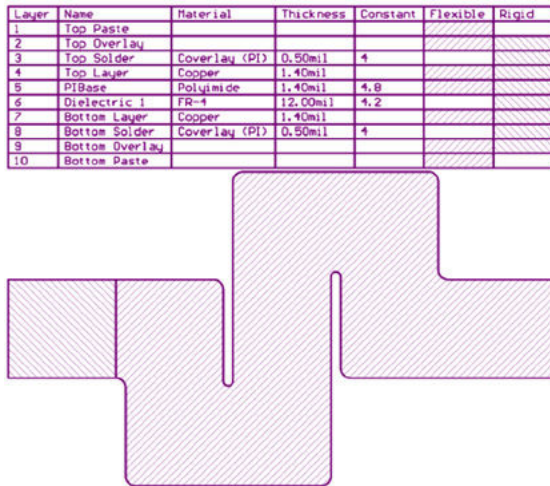
There are some issues we face if using gerber for the output data set, or earlier versions of ODB++. Namely, the fabricator will need separate route tool paths and die cut patterns for each rigid and flex circuit section in the layer stack. Effectively, mechanical layer films would need to be produced to show where voids need to be in the rigid areas, and more to show where coverlay or covercoat will be on the exposed flex circuit areas. The coverlay or covercoat also has to be considered a mask for component pads for those components that may be mounted on flex circuit areas.

IPC-2581 is also a preferred data standard, as it provides the entire database for the design and testing in a convenient XML file format. At the time of writing this standard is in early stages of refinement and adoption, but promises to be the new pervasive replacement for Gerber files.

As a designer, the question is really then, how can I define these areas, layers and stacks?

**Define the stack by area using a table**

The most important documentation you can provide your fabricator is arguably the layer stack design. Along with this, if you're doing rigid-flex, you have to provide different stacks for different areas, and somehow mark those very clearly. A simple way to do this is make a copy of your board outline on a mechanical layer, and lay down a layer stack table or diagram with a pattern-fill legend for the regions containing the different layer stacks. An example of this is shown in [Figure 3.1](#).



**Figure 3.1** An example of a stack diagram showing fill patterns for rigid and flex circuit areas.

In this example, the matching fill patterns are used for different stack areas to indicate which stackup layers are included in the Flexible part or the Rigid part. You can see here the layer item named “Dielectric 1” is actually an FR-4 core, which could alternatively be considered a stiffener.

This poses a new problem, in that you also have to define in 2D space where bends and folds can be, and where you will allow components and other critical objects to cross the boundaries of rigid and flexible sections.

**Conveying the PCB design intent**

We all know a picture is worth a thousand words. If you can generate a 3D image showing flexible and rigid areas this will help the fabricator understand your intent more clearly. Many people do this currently with the MCAD software, after having imported the STEP model from the PCB design, but it’s far better to be able to generate the imagery directly from the PCB CAD tool. **Figure 3.2** is an example of this concept.



**Figure 3.2** Bending up the mechanical model to show design intent

This of course can have the added benefit of detecting flex-to-flex and flex-to-rigid interferences ahead of fabrication. As is the case with Altium Designer, the online Design Rule Checker (DRC) interactively shows where interferences occur.

When it comes to final product assembly, it is even more desirable to provide the assembly manager and staff with a 3D animated movie of how the rigid-flex board will fold for installation into the product enclosure or assembly. This is where having a screen capture or 3D movie straight for the CAD tool can be very helpful as part of the final assembly documentation package.

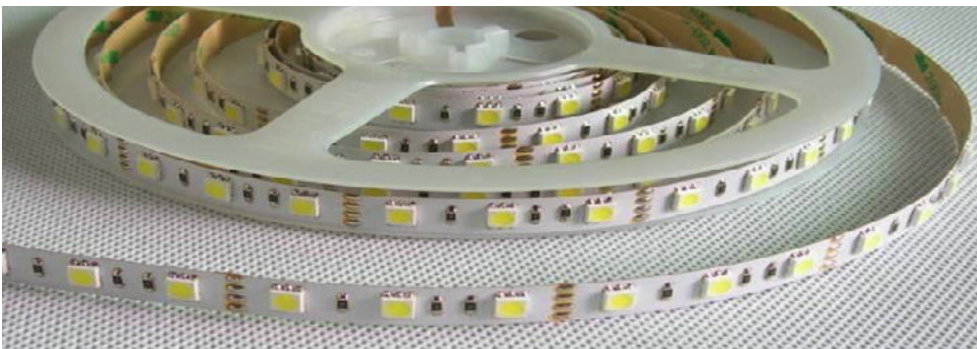
## Parts Placement

You can see also from [Figure 3.2](#), that rigid-flex designs imply that components might exist in layers other than top and bottom. This is a bit tricky in the PCB design software, because normally components must exist on top or bottom. So we need some ability to place components on inner layers.

Interestingly, Altium Designer has always supported pad objects on any layer, so this is not impossible. There's also an implication that silkscreen could exist on flex layers as well. This is not a problem, since coverlay material can adhere well to the silkscreen ink. The trick is more to make sure there's adequate contrast for the color of ink chosen against the coverlay material. Also, resolution is affected since the ink has to traverse a small gap beyond the screen to land on the flex circuit coverlay. Again, this is something that needs to be discussed with the fabricator to determine what's possible and economical.

Note: If you're going to the effort of drawing the regions of the PCB which are exposed flex layers, and placing components on those regions, this also makes a reasonable method for placing embedded components into cutout regions of the board. You need to generate a set of very clear documents that show where the cutouts are and in which sections of the layer stack they apply. This is going to be limited depending on the fabricators methods - either back-drilling or multiple laminated stack-ups can be used. So communicating your intent and minimizing the number of separate cutout stack sections is important. It's best to completely avoid having intersecting cutouts from opposite sides of the board.

Conventional wisdom calls for stiffeners or rigid sections where components will be mounted on flex anyway for dynamic applications. This is to prevent dry solder joints and copper cracks due to fatigue caused by circuit movement around rigid component pins. In some circumstances - such as the flexible LED lighting strips shown in [Figure 3.3](#), this is not necessary because the flexible strip is installed into a fixed backing, thereafter it will be static. This situation is referred to in IPC-2223 as 'Flex to Install'.



**Figure 3.3** Flex-to-Install LED lighting strip. (Source: SafestChina.com)

# DOS AND DON'TS OF FLEX CIRCUIT DESIGN

It's easy to look at the problems of layer stack design, parts placement, and cutouts and think we've got the issues down. But remember how flex circuits have some gnarly material quirks. Quirks ranging from relatively high z-axis expansion coefficients of adhesives, to the lower adhesion of copper to PI substrate and coverlay, to copper's work hardening and fatigue. These can be compensated for largely by following some Dos and Don'ts.

*"If your flex-circuit sections are going to be continually moving, bending or rolling, then you should reduce the number of layers for each sub-stack of flex, and choose adhesiveless substrates."*

## 4.1 Do Keep Flex Flexible

This may seem obvious, but it's worth saying. Decide just how much flex is needed up front. If your flex-circuit sections are only going to be folded during assembly and then left in a fixed position - such as in a handheld ultrasound device - then you are a lot freer in the number of layers, the type of copper (RA or ED) and so on you can use. On the other hand, if your flex-circuit sections are going to be continually moving, bending or rolling, then you should reduce the number of layers for each sub-stack of flex, and choose adhesiveless substrates.

Then, you can use the equations found in IPC-2223 (Eq. 1 for single-sided, Eq. 2 for double, etc.) to determine what is your minimum allowable bending radius for the flex section, based on your allowed deformation of copper and the characteristics of the other materials.

$$R = \frac{C(100-E_B)}{2E_B} - D$$

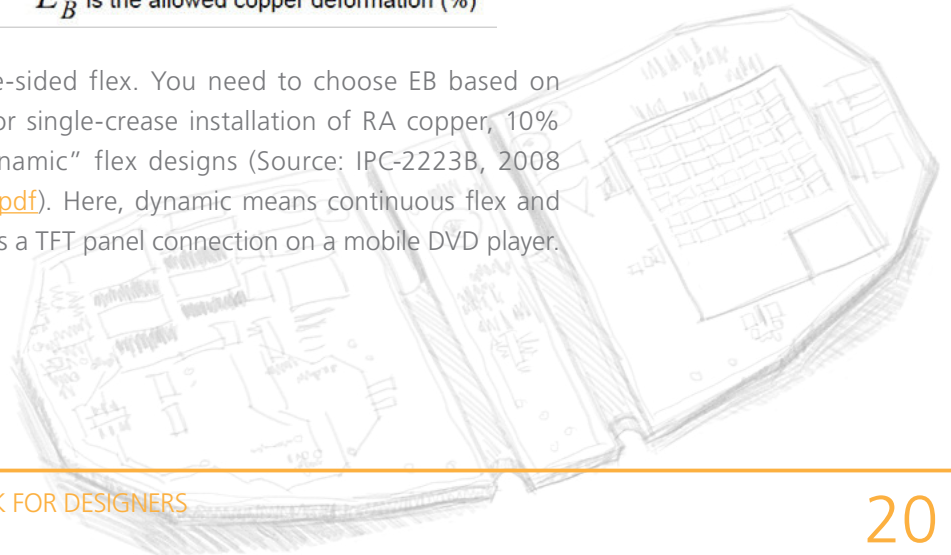
$R$  is the minimum bend radius

$C$  is the copper thickness

$D$  is the dielectric thickness

$E_B$  is the allowed copper deformation (%)

This example equation is for single-sided flex. You need to choose  $E_B$  based on the target application, with 16% for single-crease installation of RA copper, 10% "flex-to-install" and 0.3% for "dynamic" flex designs (Source: IPC-2223B, 2008 <http://www.ipc.org/TOC/IPC-2223B.pdf>). Here, dynamic means continuous flex and roll during use of the product, such as a TFT panel connection on a mobile DVD player.



**4.2 Don't Bend at Corners**

It is generally best to keep copper traces at right-angles to a flex-circuit bend. However there are some design situations where it's unavoidable. In those cases keep the track work as gently curving as possible, and as the mechanical product design dictates, you could use conical radius bends.

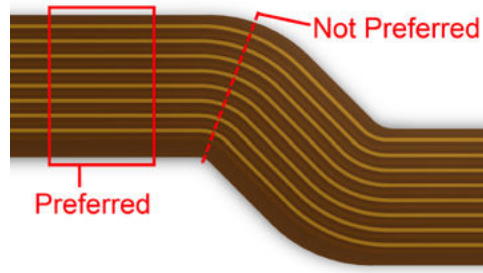


Figure 4.1 Preferred bend locations

**4.3 Do Use Curved Traces**

Also referring to Figure 4.1 above, it's best to avoid abrupt hard right-angle trackwork, and even better than using 45° hard corners, route the tracks with arc corner modes. This reduces stresses in the copper during bending.

**4.4 Don't Abruptly Change Widths**

Whenever you have a track entering a pad, particularly when there is an aligned row of them as in a flex-circuit terminator (shown below), this will form a weak spot where the copper will be fatigued over time. Unless there is going to be stiffener applied or a one-time crease, it's advisable to taper down from the pads (hint: teardrop the pads and vias in the flex circuit!)

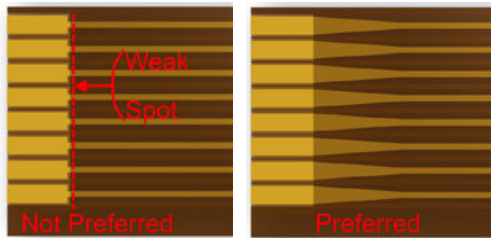
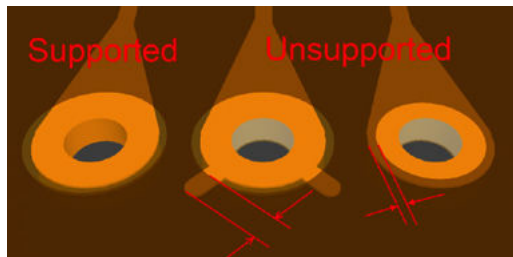


Figure 4.2 Trace width change and pad entries can cause weak spots

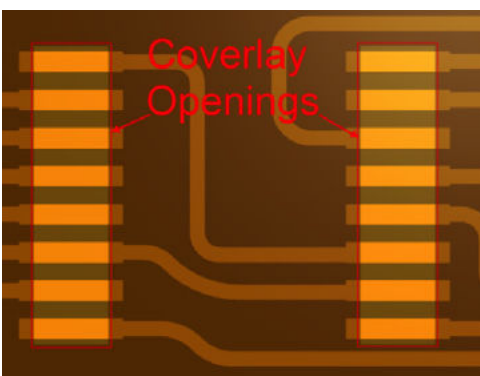
### 4.5 Do Add Support for Pads

Copper on a flex circuit is more likely to detach from a polyimide substrate, due to the repeated stresses involved in bending as well as the lower adhesion (relative to FR-4). It is especially important therefore to provide support for exposed copper. Vias are inherently supported because the through-hole plating offers a suitable mechanical anchor from one flex layer to another. For this reason (as well as z-axis expansion) many fabricators will recommend additional through-hole plating of up to 1.5 mils for rigid-flex and flex circuits, over the conventional plating in rigid-only boards. Surface mount pads and non-plated-through pads are referred to as unsupported, and need additional measures to prevent detachment.

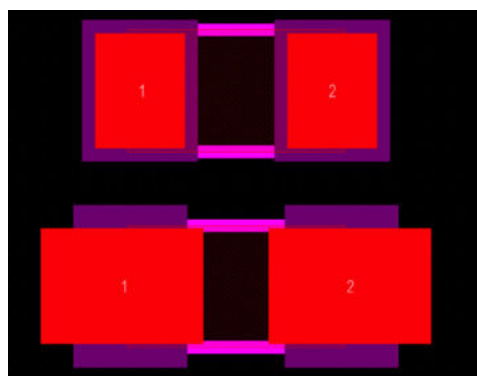


**Figure 4.3** Supporting through-hole pads in flex with plating, anchoring stubs, and reduced coverlay access openings

SMT component pads are among the most vulnerable, especially as the flex circuit may bend under the component's rigid pin and solder fillet. Figures 4.4 and 4.5 show how using the coverlay "mask" openings to anchor pads on 2 sides will solve the problem. To do this while still allowing the right amount of solder the pads have to be somewhat larger than typical rigid-board footprints would have. This is compared in Figure 4.5, with the bottom SMD footprint used for flex mounted components. This obviously reduces the density of flex circuit component mounting, but by nature flex circuits cannot be very dense compared with rigid.

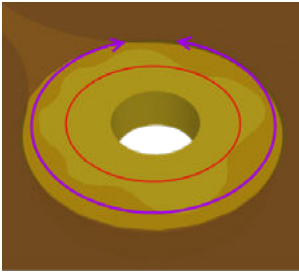


**Figure 4.4** Coverlay openings for an SOW package showing anchoring at each end of each pad



**Figure 4.5** Adjusting the pad sizes and "mask" opening for coverlay. The top land pattern is for a nominal 0603 size chip component, whereas the bottom is modified for coverlay anchoring





**Figure 4.6** Size pads and coverlay openings to allow for adhesive squeeze out.

#### 4.6 Allow for Squeeze-Out

Referring to Figure 4.6, the second option is good for adhesive coverlay and the third for adhesiveless. Coverlays attached with adhesive will exhibit “squeeze out” of the adhesive, so the pad land and the access opening must be large enough to allow for this while providing a good solder fillet. IPC-2223 recommends 360° around the hole for high reliability designs and 270° for reduced reliability flex designs.

#### 4.7 Double-Sided Flex Routing

For dynamic double-sided flex circuits, try to avoid laying traces over each other on the same direction (Figure 4.7). Rather stagger them so the tensions are more evenly distributed between copper layers (Figure 4.8).



**Figure 4.7** Adjacent-layer copper traces are not recommended



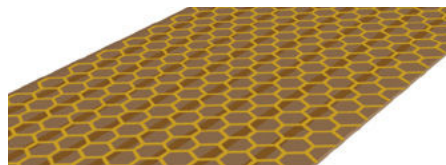
**Figure 4.8** Staggered adjacent-layer traces are preferred

#### 4.8 Do use Hatched Polygons

Sometimes it’s necessary to carry a power or ground plane on a flex circuit. Using solid copper pours is okay, as long as you don’t mind significantly reduced flexibility, and possible buckling of the copper under tight-radius bends. Generally it’s best to use hatched polygons to retain a high level of flexibility.

A normal hatched polygon still has heavily biased copper stresses in 0°, 90°, and 45° angle directions, due to alignment of hatch traces and ‘X’es. A more statistically optimal hatch pattern would be hexagonal. This could be done using a negative plane layer and an array of hexagonal anti-pads, but it’s fast enough to build the hatch below (Figure 4.9) with cut-and-paste.

This is by no means a complete set, but you should now have a few good tips on how to design flex circuits to give the best yield and highest reliability for the product - but be aware of the tradeoffs between cost, performance and reliability.



**Figure 4.9** Using hexagonal hatched polygons can spread the tension biases evenly among three angles

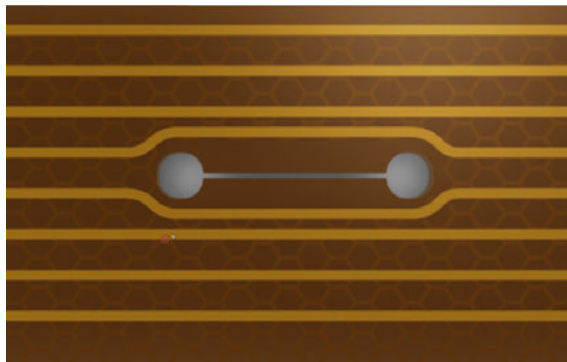
### **4.9 Via Placement**

For multi-layer flex areas, it may sometimes be necessary to place vias to transition between layers. If possible it's recommended not to place vias, as these can suffer fatigue rapidly in flexing movement. It is also necessary to keep at least 20 mils (about a ½ mm) clearance between the copper annulus of the nearest via to the rigid-to-flex board interface. Board edge clearance rules can take care of this automatically in the PCB CAD editor.

As for the need to place vias - if you must have vias in a flex circuit, use "rooms" to define regions where you know there will be no bends and use the PCB editor's design rules to allow via placement only in those stationary areas. An alternative is to use the layer stack manager to define "rigid" sections that are ultimately flex but with a rigid dielectric stiffener material adhered to them.

### **4.10 Defining Flex Cutouts and Corners**

Notice way back in [Figure 3.1](#) how there are no hard corners, but rather there's a minimum radius to each angle? IPC recommends greater radii than 1.5mm (about 60 mils), to reduce the risk of tearing of the flex circuit at corners. The same goes for slots and slits in the flex - make sure there's a designed-in relief hole at each end of diameter 3mm (1/8") or more. Another example of this is shown below.



**Figure 4.10** Slots, slits and inside corners should have tear-relief holes or tangent curves with minimum 1.5mm radius

The rule here, in essence, is that whenever you have an inside corner (a flex-circuit edge corner with angle less than 180°, always use a tangential curved corner with radius greater than 1.5mm. If the corner is much less (more acute) than 90° then have a circular curve punched out of it, as shown in [Figure 4.10](#).

In order to produce reliable rigid-flex based products, there are many considerations relating the fabrication and the end-use of the flex circuit, to the design of the copper pattern.



# APPLICATION EXAMPLES OF RIGID FLEX PCBS

## 5.1 Dynamic Flex Ideas

There are two basic reasons for designing flex into your product: to build a compact and efficiently assembled device, or to make the circuit dynamically integrated with the mechanical function of the product. You may, of course, lean on both of these reasons for justifying the use of flex circuits. In this category let's look at a couple of examples and the issues that spring to mind when designing flex circuits of this dynamic type.

### Mechatronic Gantry

A very typical dynamic flex application - this is the sort of assembly that would be used in a 3D printer or CNC machine head. Naturally, this would be laid along the X oriented gantry, and the z-axis tool head travels along it. The example in [Figure 5.1](#) is only showing 2-axes of movement here, as the gantry itself would move in the Y orientation.

The total length of flex is the most extreme end-distance needed in addition to the corners and bends.

The corner that sits behind the z-axis moving tool head would be adhered to the x-axis shuttle that moves along the gantry (probably on sleeve bearings). The ends will have stiffener added for the reliable termination of the flex circuit.

For this type of application it's best to stick to single layer Rolled Annealed copper and keep the bend radii as large as practically possible, to give a good product lifespan.

In some cases, flex circuit with stainless steel might be considered for longevity.

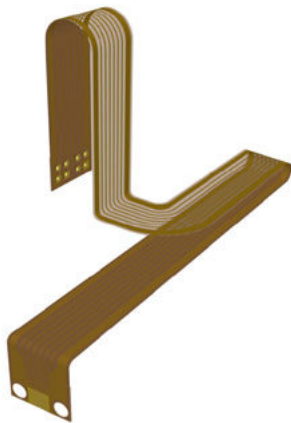


Figure 5.1 Initial design of gantry flex

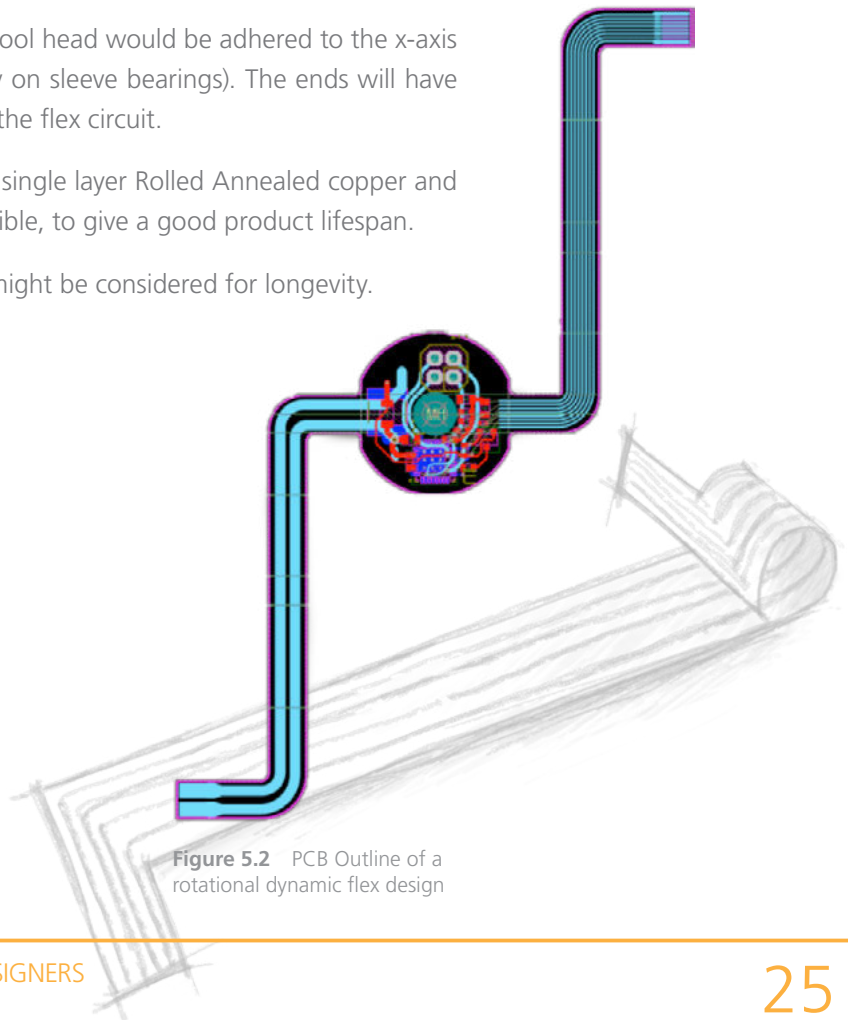


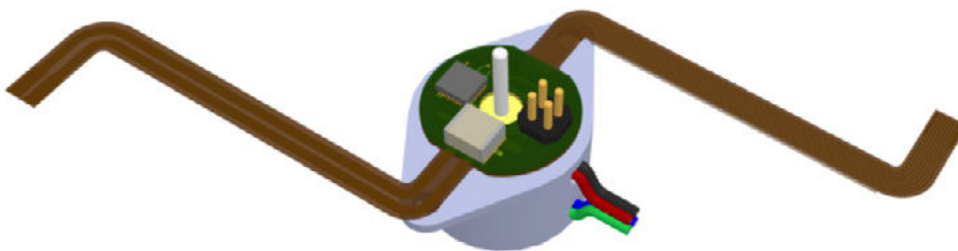
Figure 5.2 PCB Outline of a rotational dynamic flex design

### Rotational Devices

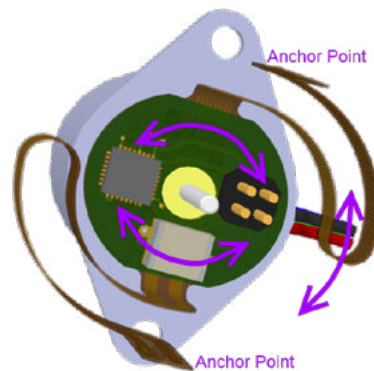
Take a look at [Figure 5.2](#), and notice the use of horizontal work guides in the PCB editor - this enables accurate design of the board outline based on the curved circumferences of the in-situ flex circuit sections. It also allows for exact placement of flex circuit bending lines in the Board Planning Mode of Altium Designer's PCB editor, which leads to accurate flex circuit bend simulation in 3D mode.

In this example, a stepper motor is to be mounted to an assembly such that the motor and its control PCB will be in motion, and the shaft will be stationary. The flex circuits are designed to be terminated at the extreme ends to a fixed base assembly, and folded into a cylinder shape, doubling back to allow bi-directional movement.

The 3D view of this design is shown with [Figures 5.3 & 5.4](#).



**Figure 5.3** 3D View of the Rotating Stepper Control Board. Longer "arms" would allow greater than 360° rotation of the motor and its control board



**Figure 5.4** The fully folded view of the assembly, including the 3D body of the stepper motor

In [Figure 5.4](#), the movement arrows and anchored flex-circuit terminators have been annotated to give an idea of the movement.

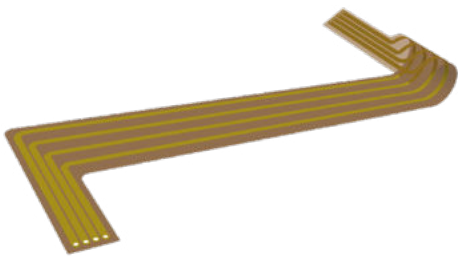
This kind of arrangement makes it relatively easy to achieve greater than 360° of rotation.

This example is hypothetical and shows a stepper motor, though this kind of design would be well suited to rotary sensor applications.

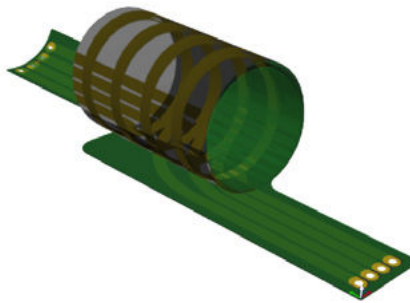
## 5.2 Static Flex Applications

### Rolled Planar Magnetics (Transformers and Inductors)

The use of flex and rigid-flex circuits for integrated planar magnetics is rising in popularity. Using flex-circuits for planar magnetics has some distinct advantages - the Polyimide film comes in thicknesses that allow very high isolation of windings, as well as its high temperature stability which makes it suitable for hot enamel potting processes. From a loss standpoint; using etched copper traces requires more width of course, but can easily reduce eddy-current losses due to the thinness of the traces mitigating skin effect.



**Figure 5.5** The un-rolled solenoid turns of a four winding inductor



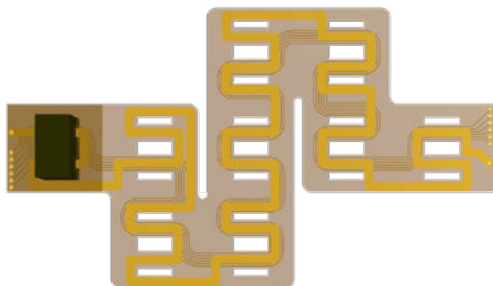
**Figure 5.6** The rolled inductor windings

A more elaborate entry and exit scheme could be used to overlap the end of each winding with the beginning of the next. This could be done to increase the number of turns versus simply having multiple separate windings, as shown in [Figure 5.6](#).

### 18 Layers for the price of 2

The natural extension of this concept is to include some flex layers in your converter design with the intent of folding them up over each other. In the example shown in [Figure 5.7](#), a 2-layer flex circuit transformer design is shown, where a single E18 planar ferrite core protrudes through cutouts in the PCB. This idea could be arbitrarily extended (albeit with practical limits of the thickness of the final folded board). In [Figure 5.7](#), the top and bottom copper layers on double-sided flex yield 18 usable layers for the transformer windings.

Around each of the core center-leg cutouts, you can make a single turn for the inductor winding. Snaking the track around a side-leg will give you half a turn, since the magnetic path area of the side legs is effectively half. This way, you may not be able to completely surround a center leg but you can make up a full turn by adding one or two extra half-turns along the way.



**Figure 5.7** Top-down view of the flex-circuit transformer. A single heavy current winding is shown on the top and six lighter current windings are on the bottom, routed using Altium Designer's multi-route tool

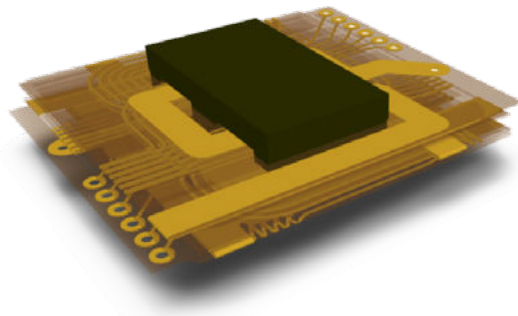
This could be confusing though, because you have to keep track of the proper winding directions with respect to each folded section's relation to the ferrite core geometry. Given that this whole flex circuit will fold orthogonally, arrows have been added on the Mechanical 1 layer of the design facing opposite to each adjacent winding layer to remind me which way to route the copper. This is shown in [Figure 5.8](#) for clarity.

The final core-and-flex assembly is shown below. Note that this could be integrated within a rigid-flex design where the majority of the circuit is on a rigid 2-layer PCB, with the flex part being used to get the additional layers needed for all the core windings. Of course, there is going to be a cost trade-off between using a large flex area versus just adding heaps of layers to a rigid-only design.



**Figure 5.8** Mechanical 1 layer showing the board outline as well as winding direction arrows for guidance

The final core-and-flex assembly is shown below. Note that this could be integrated within a rigid-flex design where the majority of the circuit is on a rigid 2-layer PCB, with the flex part being used to get the additional layers needed for all the core windings. Of course, there is going to be a cost trade-off between using a large flex area versus just adding heaps of layers to a rigid-only design.

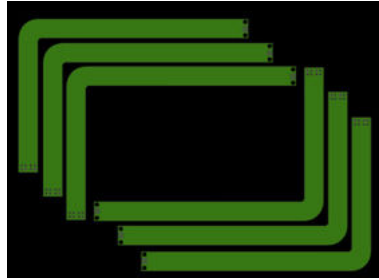


**Figure 5.9** The final completely folded-up transformer, with 3D model of the Ferrrocube E18 ferrite magnetic core through the cutouts

### 5.3 Fab Considerations

#### Panelizing

The examples above raise a good question about fabrication and cost. Using a right-angled L-shaped circuit like this we could - for argument's sake - fit six identical circuits on a fabrication panel. This results in roughly 50% waste of the panel space, and if components were to be mounted on this particular flex circuit, also add to the tooling cost and time. An example panel made from this particular flex circuit in an embedded board array is shown in [Figure 5.10](#).

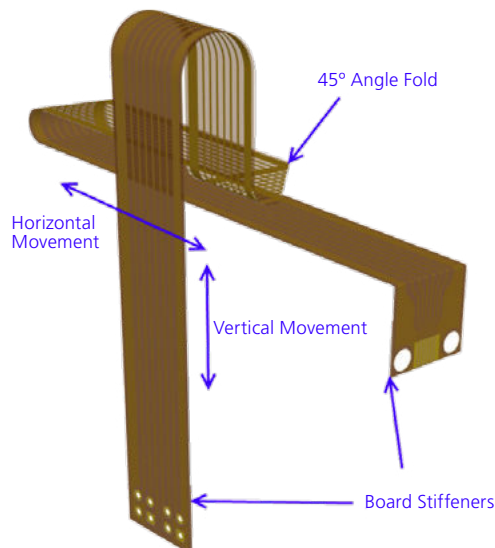


**Figure 5.10** Embedded Board Array panelization of the CNC gantry flex circuit

The good thing about flex is if we use the right materials and plan the overall assembly right, we can also create low-radius installation folds. This is a good alternative to using curved flex circuits as the one shown above, but only in certain circumstances.

[Figure 5.11](#) shows the same design done again but using a creased 45° fold to replace the 90° corner of the previous version.

The fold is suitable in this case because that part of the flex circuit is going to be adhered to a larger rigid mechanical body, and therefore it should not suffer excessive fatigue.



**Figure 5.11** Gantry flex re-designed for folding.

By doing it this way, the cost will drop significantly, and the ease of tooling for pick-and-place greatly improved. However you may have this counteracted by having to place components on the opposite side at one end of the assembly, due to the fold.

Figure 5.12 shows the same panel, with the equivalent length folded flex panelized. This doubled the panel yield!

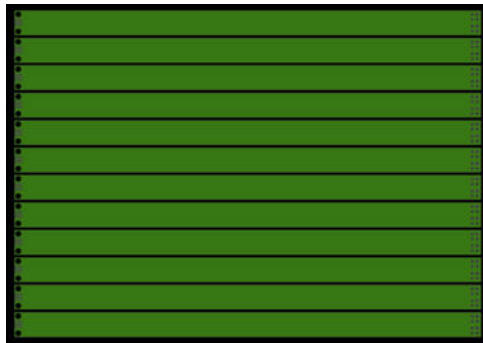


Figure 5.12 The Same panel size - the folded flex design doubles the per-panel output yield

### Planning the Layer Stack

For a pure flex circuit (as opposed to Rigid-Flex) the layer stack planning is simplified of course. However, there are still going to be anchor points for the panel, and most flex circuit designs require the placement of stiffeners in areas where there are components mounted or the circuit is terminated. Figure 5.13 shows the layer stack scheme for the gantry above, where the area with stiffener is modeled by a “rigid” stack which is locked in 3D in the PCB editor.

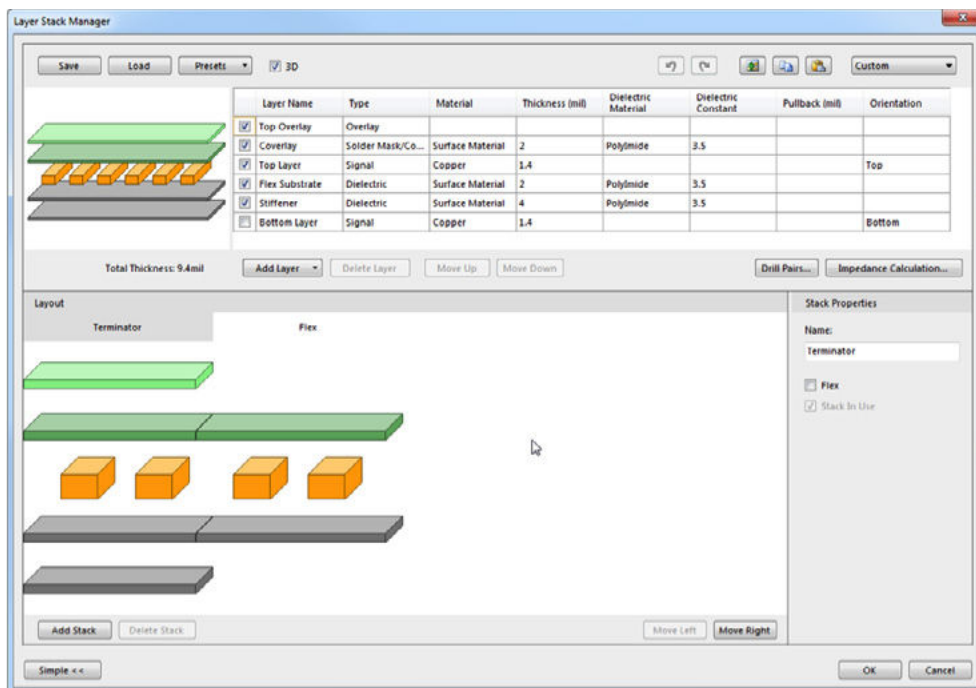


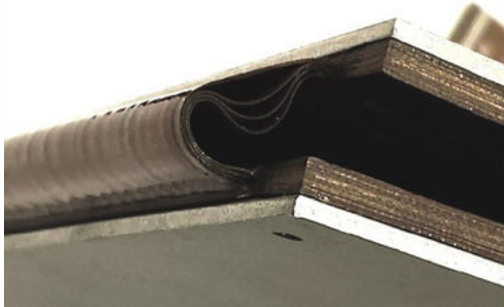
Figure 5.13 Layer Stack configuration for the flax circuit gantry example.

# MULTI-LAYER RIGID-FLEX

## 6.1 How to maintain flexibility and lifespan with multiple flex layers

For many military, aerospace or similar high-density designs that require compact, reliable assemblies in tight spaces, it's hard to avoid needing several layers of flex circuits between rigid board areas. Even more so this is necessary with high-speed digital designs, due to the requirements for shielding or plane layers between buses traversing the flex regions.

The problem here is that to maintain a good degree of flexibility, the number of flex circuit layers has to be kept to a minimum - usually two copper layers over a single PI substrate with PI coverlays.



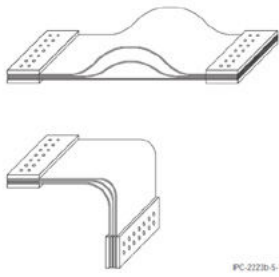
**Figure 6.1** Tensions in the outer flex circuit, and compression of the inner, result when multiple flex layers are the same length and overlap. Notice the “squeeze out” of the adhesive bead used in this design, where the flex enters the rigid section. (Photo: Ben Jordan)

In “normal” designs, the length of the flex-circuit sections is the same for overlapping flex. This means you end up with the situation shown in [Figure 6.1](#), where the folds can produce significant tensions in the flex areas between rigid boards once placed into the final assembly.

In some cases, flex circuit with stainless steel might be considered for longevity.



### 6.2 Bookbinder Construction



Most specialist rigid-flex board fabricators at this point would tell you to use “bookbinder” construction. Bookbinder construction is a viable method where the in-situ radius of the flex circuit bends is used to determine the correct length for each flex circuit and substrate combination in the layer stack. An example illustration of the concept is shown in Figure 6.2.

Figure 6.2 Bookbinder construction (source: IPC-2223B, 2008 p26)

To work out the additional length needed for each flexible circuit layer above the innermost layer, use the cross-sectional center to center height difference between them, H. Referring to Figure 6.3, the length needed for the innermost flex circuit between rigid sections is the flat lengths, L1 and L2, added to the length of the bent section, given by:

$$L_i = \frac{\theta\pi}{180} \cdot R_i + L_1 + L_2$$

Then, the next flex circuit bend is given by the difference in radii of H:

$$L_0 = L_i + \frac{\theta\pi}{180} \cdot H$$

Of course, carry this out for however many separate flex layers there are.

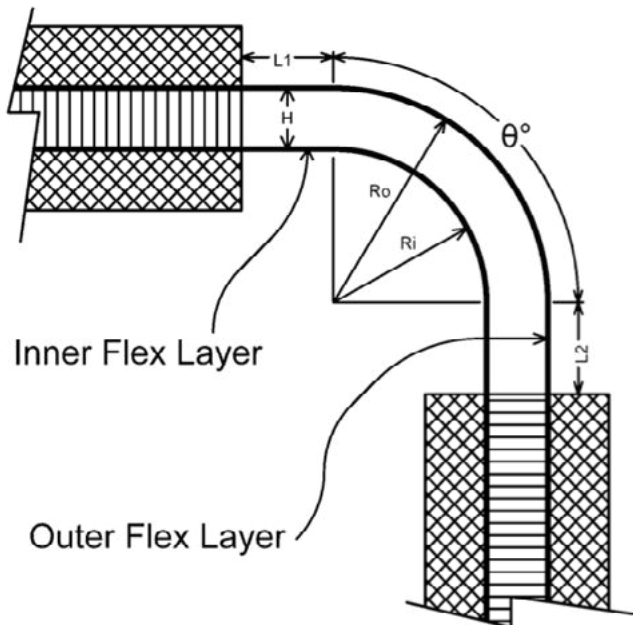


Figure 6.3 Angles and lengths for calculating overall flex circuit lengths of bookbinder



### 6.3 Staggered Flexible Layer Bands

You can tell immediately the bookbinder method is going to cost money and increase the challenge of design somewhat. Often a better alternative is to use the same length and radius flex-circuits, but separate the different flex circuit layers to not overlap each other. An example of this is shown in Figure 6.4.

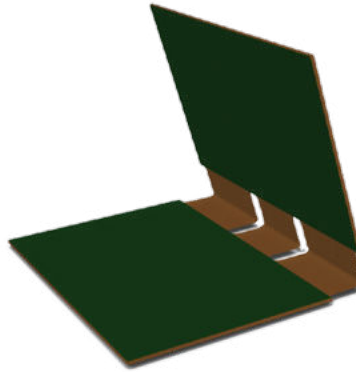


Figure 6.4 Staggered Flexible Layer Bands Construction

In the Staggered Layer Bands design method, there is a trade-off between having a large number of signals traversing the flex circuit versus cost and flexibility. For example, if a 3" wide double-sided flex allows 400 connections to cross it, and we have three flex circuit layers, then the bookbinder construction allows 1200 connections between rigid board sections. Using the staggered layer bands, we would get 400 connections or less, because no two double-sided flex layers are overlapping. However the cost is lower and the circuit will have greater longevity.

### 6.4 Getting Ultra-tight bends without sacrificing layer count

Figure 6.5 shows a tiny board which uses several S shaped flex lobes to increase the minimum bend radius between the sections that had components mounted on them. It's not visible in this photo, but the components are mounted on sections that have thin stiffener adhered on the back side of the board.

This concept can be extended in multiple directions of course. The design shown in Figure 6.6 is an ultra-flexible display board. You can see the many LEDs in a matrix on the wider, stiffer sections. The whole assembly is more rigid in those sections only because of the sheer number of copper and PI film layers laminated together. Again, using S-bends between those makes this whole thing able to bend into a curved housing. Each LED is individually addressable in a matrix, so there are a lot of separate traces in this design.

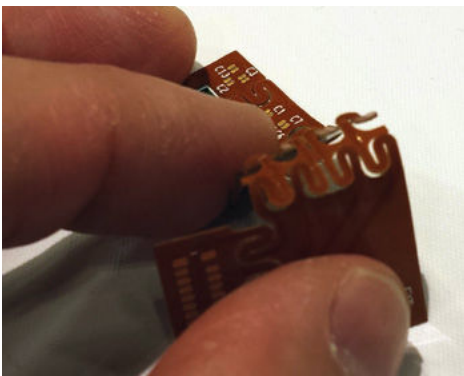


Figure 6.5 Getting essentially 180° bend radius with multiple copper layers. (Photo: Ben Jordan)

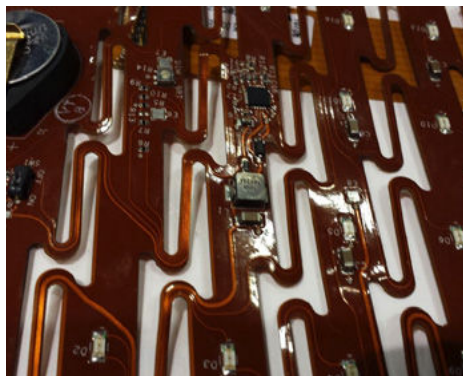
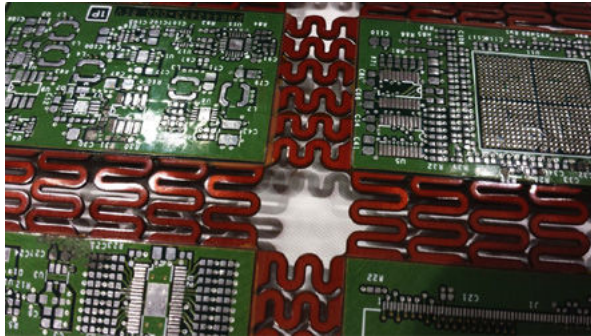


Figure 6.6 X-Y S-bend flex array. (Photo: Ben Jordan)

### 6.5 Single Many-Layer Flex

Take that concept from Figure 6.6 even further, and you have the insanely cool application in Figure 6.7. This is a VERY compact design, from a product designed to be worn in specialized apparel. The flex-circuit sections alone are 8 layers. As they were, such flex circuits would not be flexible enough at all. But using the myriad S-bends (notice the top flex layers are all solid copper for shielding!) allows this to bend enough to go into the final mechanical housing, even with hundreds of high speed memory and display connections.



**Figure 6.7** 8 Layers of flex, plus 4 additional rigid layers. Notice the top layer of flex is entirely copper pour for shielding. Notice also the protective adhesive around the edges of the rigid-to-flex interfaces.  
(Photo: Ben Jordan)

### 6.6 Flex Circuit Follies

And for really creative designers, there's always one more application, shown in Figure 6.8.

This raises a serious point though - flex and rigid-flex circuit technology is an enabler, and can be used effectively and economically in a wide variety of applications - consumer toys and electronics included.



**Figure 6.8** Who said Rigid-Flex meant no more origami?  
(Photo: Ben Jordan)

# CONCLUSION

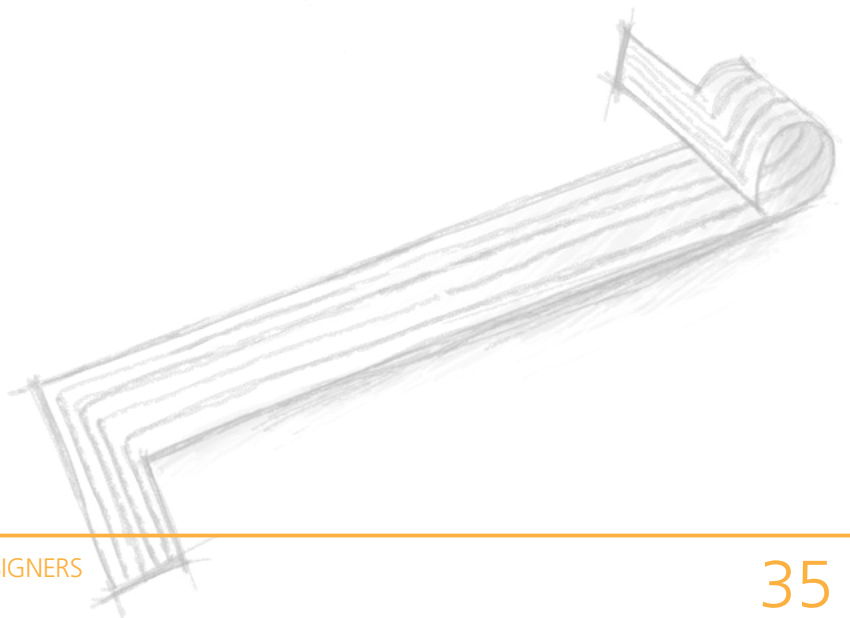
---

Advancement of modern electronics technology, and the mobile industry in particular, has introduced a unique set of challenges, and pitfalls, for designers. To this end, rigid-flex design provides a solution for compact and dense printed circuit boards.

Adding flexible regions to a PCB requires several additional considerations to conventional rigid board design methods. A designer must take into account things such as specific material types, intended application of the product, manufacturing documentation, and the fabrication processes necessary to maximize production yield. It is critical that a designer understands these concepts and maintains strong communication with a manufacturer to ensure swift and seamless development.

This guidebook is intended as a useful starting point for any designer, new or experienced. Whether they are beginning their first rigid flex design, or have successfully completed several, this guidebook aims to promote good design practice. Regardless, these guidelines and suggestions by no means cover the entire spectrum of flex and rigid-flex design concepts, and should always be followed by extensive research and review specific to each design.

Happy designing!



# BIBLIOGRAPHY

1. Coombs, CF 2008, Printed Circuits Handbook, 6th edn, McGraw-Hill, New York, NY
2. IPC 2011, Sectional Design Standard for Flexible Printed Boards, IPC-2223C, IPC, Bannockburn, Illinois.
3. Thermal Conductivity Polyimide Film 2013, Shinmax Technology Ltd., Taiwan, viewed 25 October 2013  
[http://shinmax.taiwantrade.com.tw/products-detail/en\\_US/542706/Thermal\\_Conductivity\\_Polyimide\\_Film](http://shinmax.taiwantrade.com.tw/products-detail/en_US/542706/Thermal_Conductivity_Polyimide_Film)
4. TCM125-OE, Zhuhai Smartech Electronics & Machinery, China, viewed 25 October 2013  
<http://www.vcdpickup.com/thomson.files/TCM125-OE.jpg>
5. Machined Class A Die Coverlay 2011, GC Aero Inc., United States, viewed 25 October 2013  
<http://gcaero.com/wp-content/uploads/2011/11/Punched-Coverfilm.jpg>
6. Fine Blanking Die SKD11 / Din1.2379 For Flex Printed Circuit Board 2013, Haoji Stamping Tool & Die Co.,Ltd., China, viewed 31 October 2013  
[http://www.metal-stampingdie.com/china-fine\\_blanking\\_die\\_skd11\\_din1\\_2379\\_for\\_flex\\_printed\\_circuit\\_board-1262774.html](http://www.metal-stampingdie.com/china-fine_blanking_die_skd11_din1_2379_for_flex_printed_circuit_board-1262774.html)
7. 1.6mm Immersion Gold FR4 & PI 6 Layer Rigid Flexible Board / Multilayer Printed Circuit Board 2013, YYUXING Shenzhen Electronics Co., LTD., Korea, viewed 25 October 2013  
[http://www.china-pcbmanufacturer.com/photo/pl425064-fr4\\_pi\\_6\\_layer\\_immersion\\_4\\_4mgold\\_flexible\\_printed\\_circuit\\_board\\_assembly\\_for\\_led.jpg](http://www.china-pcbmanufacturer.com/photo/pl425064-fr4_pi_6_layer_immersion_4_4mgold_flexible_printed_circuit_board_assembly_for_led.jpg)

# ADDITIONAL RESOURCES

## Reference Design Links (Altium Designer 14 Format)

CNC Gantry Flex Circuit:

[http://www.altium.com/download.php?file=PCB\\_CNCGantry\\_Guidebook\\_Reference.zip](http://www.altium.com/download.php?file=PCB_CNCGantry_Guidebook_Reference.zip)

Rotating Stepper Control Board:

[http://www.altium.com/download.php?file=PCB\\_RotatingSensor\\_Guidebook\\_Reference.zip](http://www.altium.com/download.php?file=PCB_RotatingSensor_Guidebook_Reference.zip)

Rolled Four Winding Inductor & Flex Circuit Transformer:

[http://www.altium.com/download.php?file=FlexTransformer\\_Guidebook\\_Reference.zip](http://www.altium.com/download.php?file=FlexTransformer_Guidebook_Reference.zip)

Bluetooth Sentinel Modified:

[http://www.altium.com/download.php?file=S-Bends\\_Guidebook\\_Reference.zip](http://www.altium.com/download.php?file=S-Bends_Guidebook_Reference.zip)

## Altium Designer Rigid-Flex Documentation

PCB Layer Stack Management

<http://techdocs.altium.com/display/ADOH/PCB+Layer+Stack+Management>

Defining Board Regions and Bending Lines

<http://techdocs.altium.com/display/ADOH/Defining+Board+Regions+and+Bending+Lines>

Documenting the Layer Stack

<http://techdocs.altium.com/display/ADOH/Documenting+the+Layer+Stack>

PCB Layer Stackup Technology and Terminology

<http://techdocs.altium.com/display/ADOH/PCB+Layer+Stackup+Technology+and+Terminology>

Flex and Rigid-Flex Printed Circuit Design

<http://techdocs.altium.com/display/ADOH/Flex+and+Rigid-Flex+Printed+Circuit+Design>

Presenting a Rigid-Flex Design in 3D

<http://techdocs.altium.com/display/ADOH/Presenting+a+Rigid-Flex+Design+in+3D>

Designing with Embedded Components

<http://techdocs.altium.com/display/ADOH/Designing+with+Embedded+Components>

## Videos

Design New Layer Stacks

<http://www.altium.com/en/video-define-new-layer-stacks>

Layer Stack Regions

<http://www.altium.com/en/video-layer-stack-regions>

Bending Lines

<http://www.altium.com/en/video-bending-lines>

Embedded Components Support

<http://www.altium.com/en/video-embedded-components-support>

# GLOSSARY

<b>Coverlay</b>	Special material used to insulate the outer surface conductors of a flexible PCB region. Protects against corrosion and damage, similar to how solder mask is used on rigid sections. Polyimide and Polyester are two common materials used as coverlay.
<b>Substrate</b>	Base dielectric material used in PCBs. Flex circuits are simply manufactured using Polyimide or Polyester films as substrate material, while cured epoxy is added in rigid sections to stiffen the board area.
<b>Rigid-Flex</b>	Term used for circuit design incorporating both rigid and flexible regions on the same board. There are many applications for rigid-flex design, including densely populated electronics, integration with mechanical functions of a product, planar magnetics, etc.
<b>Polyimide (PI)</b>	Material commonly used for substrate and coverlay films in flex circuits. It can support high-temperature processes such as soldering and wire bonding, making it ideal for most applications. It is higher cost than other standard films such as Polyester.
<b>Polyester (PET)</b>	Material commonly used for substrate and coverlay films in flex circuits. It is not tolerant of high temperatures, but is more dimensionally stable than Polyimide. Typically, PET film is used in low-cost electronics where no soldering process is necessary, but strong mechanical performance is required at room temperature.
<b>Electro-Deposited (ED)</b>	Copper foil traditionally used with standard rigid PCBs. One of the most cost effective conductor options, but generally not suitable for flex applications.
<b>Rolled Annealed (RA)</b>	Copper foil used for dynamic flex purposes, offering more durability and endurance. Electro-deposited copper foil is passed through high-pressure rollers, elongating the grain structure in a planar orientation, and making the copper more flexible and springy.

<b>Coverlay</b>	Special material used to insulate the outer surface conductors of a flexible PCB region. Protects against corrosion and damage, similar to how solder mask is used on rigid sections. Polyimide and Polyester are two common materials used as coverlay.
<b>Adhesive</b>	Material used to bond copper foil to substrate and coverlay films on flex circuits. In rigid boards, heat and pressure are adequate for creating a reliable bond, without the use of adhesive. Rolled annealed copper foil, used with flex circuits, has less “tooth” than electro-deposited, and does require the use of adhesive. Acrylic and epoxy resins are two common types of adhesive.
<b>Panel</b>	Large board used to hold several PCBs at once during fabrication or assembly. Rigid-flex boards are held together during assembly, and blanking is done afterwards to remove them from the panel.
<b>Blanking</b>	Cost-effective method of cutting PCBs from a Panel. High-volume production runs will use a hydraulic punch and die set, while lower-volumes will instead be cut using a blanking knife.
<b>Lamination</b>	Process of bonding layers together during PCB fabrication. Flex circuits are laminated into the rigid sections to form a combined stackup.
<b>Static Flex</b>	Application of flexible circuits where the flexible part is folded, creased or curved during installation into the product’s mechanical enclosure, and then remains in a fixed position.
<b>Dynamic Flex</b>	Application of flexible circuits where there is constant movement of the flexible circuit bends.
<b>Layer Stack</b>	Collection of layers comprising a PCB. Rigid and flex sections of a board will have separate layer stacks, each with their own considerations for layer type and material. Can also be referred to as a stackup.
<b>Adhesive Beads</b>	Strengtheners used where a flex circuit exits the rigid board. Automatic fluid dispensing can be used to apply beads of acrylic or epoxy resin, but caution must be taken to prevent excess glue from dripping under the assembly. Often, application must be done by hand.
<b>Stiffener</b>	Extra material, usually thick Polyimide or FR-4, added to the extreme end of a flex circuit. Stiffeners are applied to enhance durability at the termination of a flex circuit to a connector or main rigid board.
<b>Covercoat</b>	An alternative to laminated coverlay film, which is applied over the outer copper layers of the flex circuit through a mask, much like screen printing or painting.

<b>Coverlay</b>	Special material used to insulate the outer surface conductors of a flexible PCB region. Protects against corrosion and damage, similar to how solder mask is used on rigid sections. Polyimide and Polyester are two common materials used as coverlay.
<b>Die (or, Punch)</b>	A custom made tool for cutting unwanted film out of the flexible circuit laminates.
<b>Affected Area Width</b>	The width of surface area on a flexible circuit that will be bent, for the given Bending Radius and Bending Angle.
<b>Pressure Sensitive Adhesive (PSA)</b>	Adhesive which forms a bond when pressure is applied. No heat or other materials are needed to activate the adhesive.
<b>Exposed Area</b>	An exposed area of an inner layer and it's associated coverlay (could also be used for embedded components).
<b>Signal Flex</b>	A signal layer for a flex circuit.
<b>Power Ground Flex</b>	A power or ground layer for a flex circuit.
<b>Mixed Flex</b>	A mixed (signal and power/ground) layer for a flex circuit.
<b>Plating Mask</b>	A mask for defining which areas within a layer should be masked off from plating process.
<b>Immersion Mask</b>	A mask for defining which areas within a layer should be masked off for immersion gold.
<b>Layer Stack Diagram</b>	Drawing showing the layout and orientation of rigid and flexible regions on a PCB. Typically included as part of the Fabrication Notes.
<b>Embedded Component</b>	Component placed on an internal PCB layer. Embedding components can be done for several reasons, including reducing space in very dense designs, and shortening return lengths in high speed applications.
<b>Trace Width Taper</b>	Preferred method of pad entry on a flex circuit. If no taper is added when a track enters a pad, particularly with an aligned row of them as in a flex circuit terminator, a weak spot will form and the copper will be fatigued over time.
<b>Supported Hole</b>	Hole with copper plating added to its interior to provide a mechanical anchor between layers. Supported holes are needed for flex and rigid-flex circuits, since copper is more likely to detach from a Polyimide substrate, due to the repeated stresses involved in bending as well as lower adhesion (relative to FR-4).



<b>Coverlay</b>	Special material used to insulate the outer surface conductors of a flexible PCB region. Protects against corrosion and damage, similar to how solder mask is used on rigid sections. Polyimide and Polyester are two common materials used as coverlay.
<b>Unsupported Hole</b>	Hole with no copper plating added to its interior. Not recommended for flex or rigid-flex circuits, due to the lower adhesion of copper to Polyimide, relative to FR-4.
<b>Squeeze Out</b>	Oozing of excess adhesive from coverlay openings. When squeeze out occurs near a through-hole pad, the land and access opening must be large enough to still provide a good solder fillet.
<b>Bending Angle</b>	Angle with which the surface of a flex region is to bend. Inter-related to Affected Area Width and Bending Radius.
<b>Bending Radius</b>	Distance away from the bend surface that the bending center point is located. Inter-related to Affected Area Width and Bending Angle.
<b>Board Planning</b>	Realm of flex circuit design related to defining board regions and bending of those regions.
<b>Bookbinder Construction</b>	Recommended construction technique for reliably interconnecting multiple flexible layers within a short distance. Flexible layers at the outer side of the flexible area should be longer, providing uniform gaps between the flexible layers when bent.
<b>Split Line</b>	Line used to define separate board regions in a rigid-flex design.
<b>Cavity</b>	Chamber created internally in a PCB to allow clearance for an Embedded Component body.
<b>High-Density Interconnection (HDI)</b>	Collection of design methods used to significantly increase routing density. There are unique challenges presented when designing HDI or Ultra HDI flex circuits.