

# SF-PC5000 Electromagnetic Noise Shielding Film for FPC Applications

The increasing diversity of mobile phone design has led to an expansion in the market. In addition to the popular clam-shell style, the new slide style cellular phone has become a hit. Recently, it became difficult to create new designs for clam-shell phones. Consequently, manufacturers have been searching for a new design, resulting in the slide style cellular phone. Tatsuta introduces a new type of electronic magnetic noise-shielding film for flexible printed circuits (hereafter referred to as FPC), the SF-PC5000. The ultra-thin SF-PC5000 features high flexibility to meet the demands of sliding and shielding performance without degradation of flexibility intrinsic to FPCs.

## Introduction

FPCs are being widely used in mobile equipment for wiring because of its high flexibility and its ability to be used in a wide range of design styles. This type of electronic equipment requires flexibility and high-speed operation as well as comprehensive magnetic noise shielding. In view of this trend, our company developed and released the SF-PC1000 in March 2000. It has been used extensively in mobile equipment such as cellular phones, digital cameras and camcorders. However, recent market trends have seen mobile equipment becoming even more rapidly smaller and lighter as well as requiring a high degree of design freedom. Especially now, cellular phones have a wide variety of styles beyond the standard clam-shell style. New designs include the slide or revolver type of cellular phones. In addition to the SF-PC1000, which featured advanced dynamic bending and flexibility, we also developed and released the SF-PC5000 (Photo 1). The SF-PC 5000 is ultra thin (22  $\mu\text{m}$  in thickness) and features high flexibility and high shielding performance without degrading the flexibility that is intrinsic to FPCs and COFs (chip on flex).

The SF-PC5000 has made the slim design of slide type cellular phones possible and delivers better sliding endurance than that of the silver paste shielding. The insulation layer consists of a flexible-resin layer and a friction-resistant layer formed by casting. This article mainly introduces the structure and characteristics of the SF-PC5000 and then presents electromagnetic noise shielding materials designed for FPCs and COFs.



Photo 1 SF-PC5000 shielding film for FPCs and COFs applications

## Structure and Features

The cross-sectional structure of the SF-PC5000 is shown in Fig.1. The SF-PC5000 consists of 5 layers; the transfer film, insulation, metallic deposition, anisotropic conductive adhesion and protection film, the same as the SF-PC1000. However, the transfer film for the SF-PC5000 utilizes a heat-resistant resin originally developed by Tatsuta, which is formed by casting. Also, the insulation layer of the SF-PC5000 consists of a two-layer structure compared with the main body of the SF-PC1000, which uses as the base film a highly heat-resistant PPS (Polyphenylene Sulfide) film 9  $\mu\text{m}$  thick.

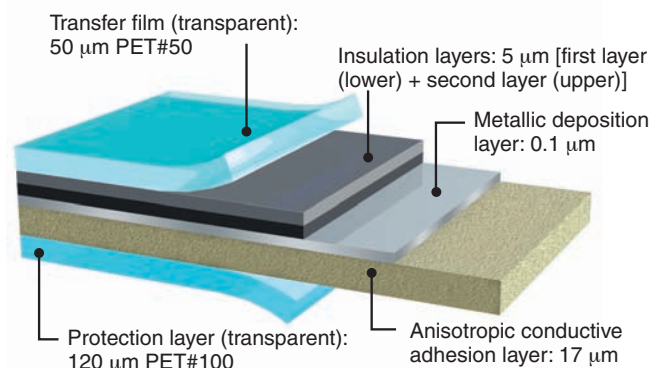

Fig.1 Cross-sectional structure of the SF-PC5000

Using an ultra-thin resin layer as the insulation layer, bonding the SF-PC5000 to the FPC by thermal pressing was dramatically improved. The successful development of a thinner thermosetting anisotropic conductive adhesive layer has resulted in a total thickness of just 22  $\mu\text{m}$ , 33% thinner than the SF-PC1000.

In consideration of working efficiency and processability during the bonding process to a FPC, transfer film is laminated to the insulation side and protection film is laminated to the conductive adhesive side.

These films are removed during processing of the FPC. In the end, only the four-layer structure (two insulation layers / metallic deposition layer / anisotropic conductive adhesive layer) is added to the FPC.

#### Features of the SF-PC5000

- Ultra thin body of 22  $\mu\text{m}$
  - Increased sliding performance and flexibility
  - Supports moisture absorption reflow-soldering
  - Excellent dimensional stability
- Others
- 1) Printing and bonding reinforcement plate is possible
  - 2) Pressing time can be reduced
  - 3) Color of insulation layer is mat black

The features of the SF-PC5000 are shown below.

#### 1. Ultra thin body of 22 $\mu\text{m}$

Insulation layer consists of two layers. The first Insulation layer is flexible and the Second Insulation layer has excellent-friction resistance.

#### 2. Increased sliding performance and flexibility

Higher sliding performance that is prior to silver paste can make slide type cellular phone slimmer.

#### 3. Supports moisture absorption reflow-soldering

Improved and thinner insulation resin reduces gas barrier. Also completely compatible with lead-free soldering.

#### 4. Excellent dimensional stability

The thermal shrinkage rate for the insulation resin is one tenth of existing PPS. Slim FPC or COP is shielded on one side, drastically reducing curling.

#### 5. Others

- 1) Printing and bonding reinforcement plate is possible.
- 2) Pressing time can be reduced.
- 3) Color of insulation is mat black.

## Typical Characteristics

### Shielding resistance (IPC flexure) endurance

The result of the IPC flexural endurance test is shown in Fig.2.

The flexural endurance of the one-side-shielded FPC by the SF-PC5000 is better than that of the silver-paste-shielded FPC. The endurance is about 3 million cycles when the radius curvature is 1.5 mm. Thus, the SF-PC5000 has achieved a level where it can be used as a practical shielding material for slide type cellular phones and PDAs.

The test condition is shown in Table 1.

Table 1 IPC flexural endurance test (FPC shielded one side)

[Cycle]

Bending radius (mm)	SF-PC5000	Silver paste
1.0	320,000	227,000
1.5	2,880,000	1,800,000

Fig. 2 Bending resistance

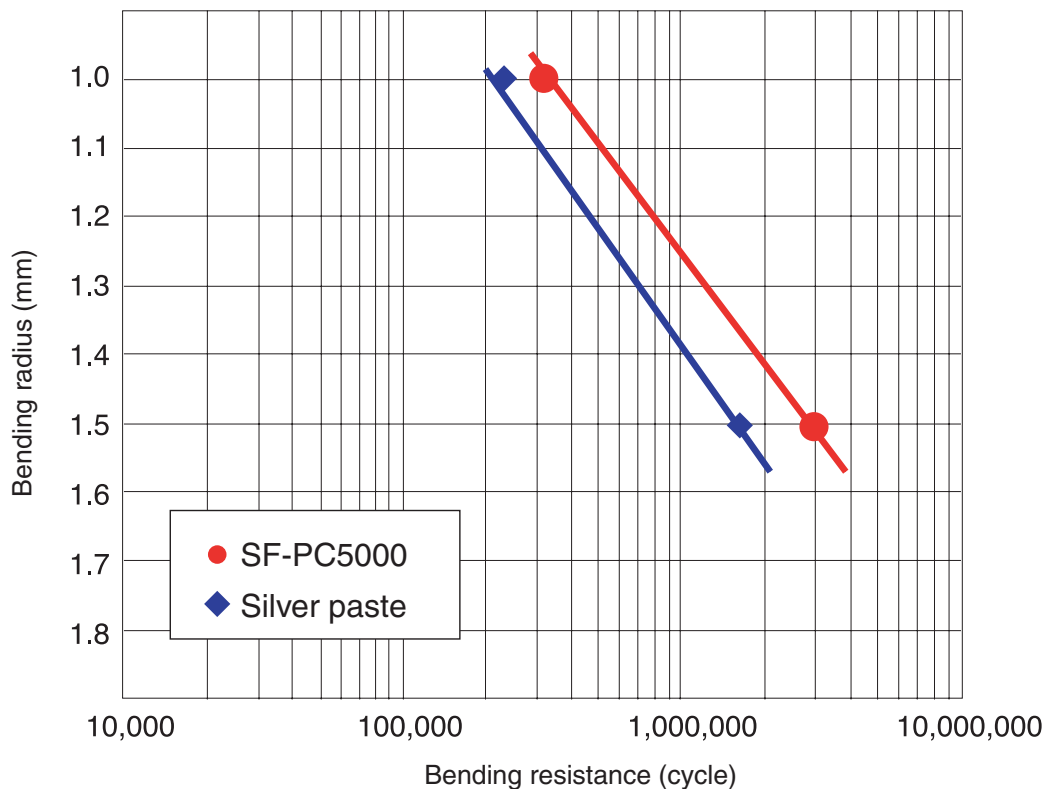

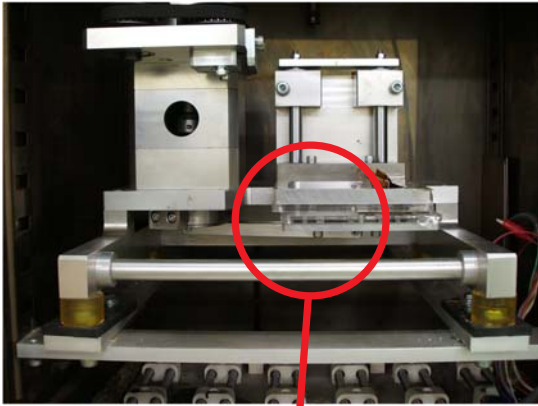

**Test conditions**

- (1) Temperature: 23°C
- (2) Stroke: 30 mm
- (3) Sliding cycles: 1000 cycles/min.
- (4) FPC
  - CCL: 45.5 μm (PI 12.5 μm)
  - Copper foil: 18.0 μm
  - CL: 27.5 μm
  - Pattern: L/S = 0.12/0.1
  - 6 lines: L = 145 mm

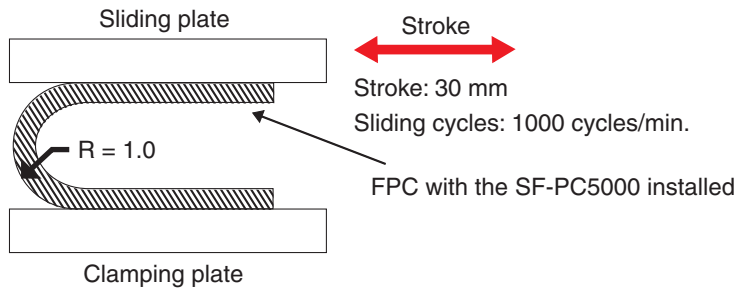
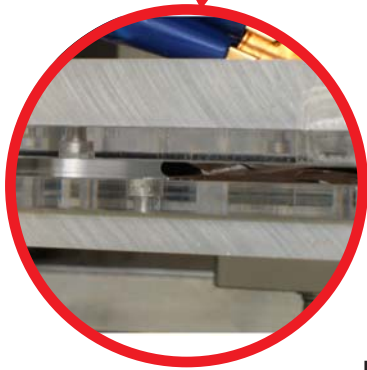

**Fig. 3 IPC flexural endurance test**

**Moisture absorption reflow-soldering**

Using PPS film as its base film, the SF-PC1000 provides good gas barrier performance, thus the FPC shielded with the SF-PC1000 is required to be prebaked so that it won't have blisters by moisture absorption. Meanwhile, as shown in Photo 2, the SF-PC5000 does not cause blisters even without pre-baking. Table 2 shows that the SF-PC5000 absorbs more moisture than the SF-PC1000 does but the moisture absorption rate has become lower after the reflow test. A possible reason is that the SF-PC5000 has high gas permeability.

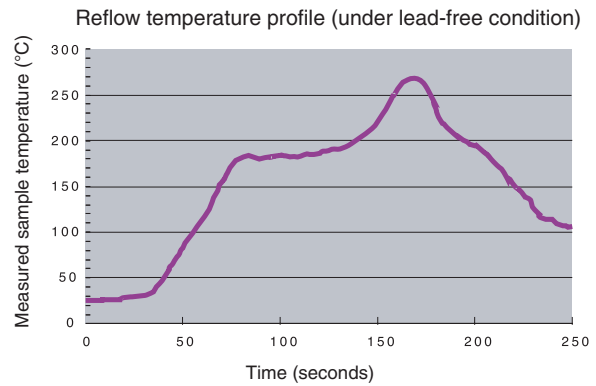

**Fig. 4 Views after moisture absorption reflow-soldering**

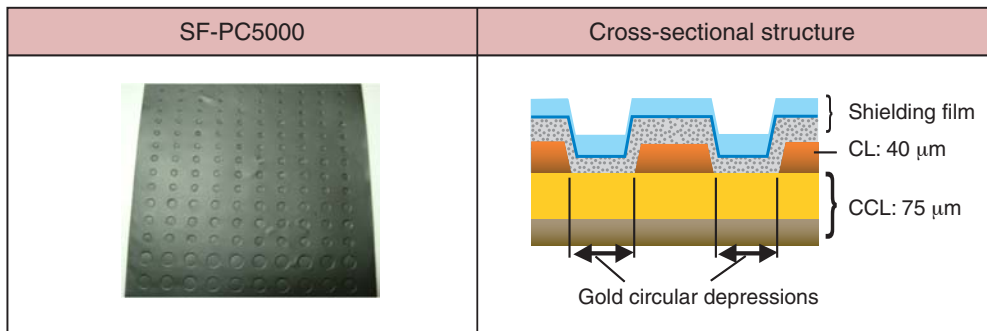

Moisture absorption reflow condition: PCT (120°C / 100%RH / 2 atm / 24 hr) → Reflow

**Table 2 Change in moisture absorption**

Moisture absorption (40°C / 90%RH) x 96 hr moisture absorption rate after exposure	0.25%
Moisture absorption rate after reflow	-0.40%
Reduced sample moisture after reflow	0.65%

## Dimensional stability

FPC with the SF-PC1000 sometimes warp because the base film used in the SF-PC1000 shrinks when it's heated. However, the thermal shrinkage rate of the SF-PC5000 is one-tenth of that of PPS and this low thermal shrinkage rate drastically reduced curling of the FPC. The SF-PC5000 is particularly optimal to thin COF products. (Photo 2)

Item		SF-PC5000	Remark
Curing conditions		170°C x 1 + 3 min. 150°C x 60 min.	* Press condition
Tg	Measured by DMA	50°C	
Elasticity	Measured by DMA	6.0 Gpa	
Tensile strength	MD direction	20 MPa	• Tensile speed: 55 mm/min. • Measuring sample: 15 x 150 mm
	TD direction	21 MPa	
Breaking elongation	MD direction	1.1%	* The measuring sample is created with curing oven.
	TD direction	1.1%	
Thermal shrinkage (170 hr x 1 hr)	MD direction	0.1%	* Shielding film only
	TD direction	0.1%	
Thermal shrinkage (after reflow)	MD direction	0.1%	* Shielding film +25 mm (Kapton 100H) attached
	TD direction	0.1%	

### Curling test by heat-resistance reflow

Workpiece size:  
155 mm x 100 mm  
Workpiece components:  
CCL 45.5 mm (PI 12.5 μm) and  
CL 27.5 mm (PI 12.5 μm)  
Shielding film size:  
150 mm x 65 mm

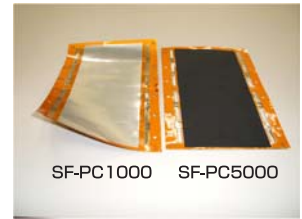
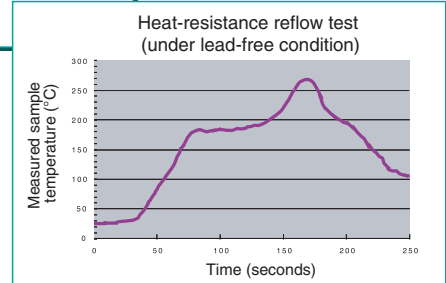
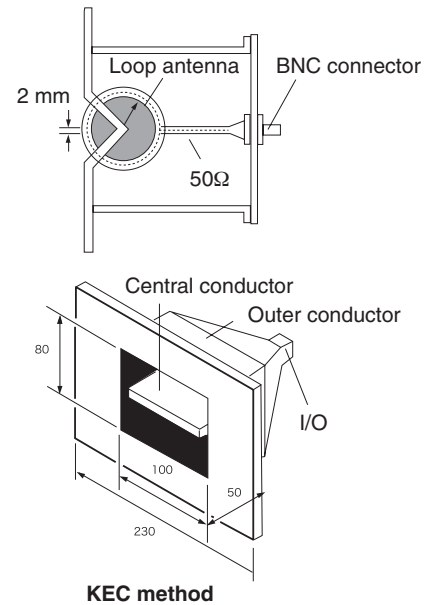
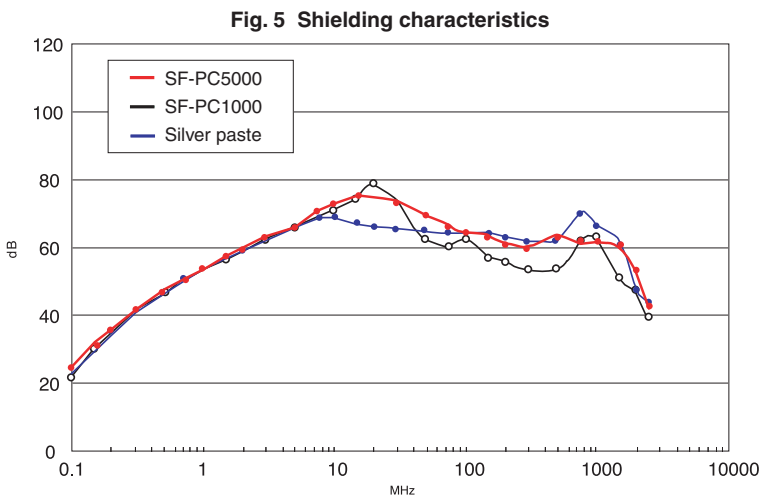

Photo 2 Curled film



## Shielding characteristics

The shielding characteristics measured with the KEC method are shown in Fig. 5. As the SF-PC5000 has the same shielding layer structure as that of the conventional SF-PC1000, the shielding characteristics are also the same as that of the SF-PC1000 in a wide range of equipment.



## Others

As with the SF-PC1000, the SF-PC5000 can be laminated to FPC using a press machine generally used for manufacturing FPC. The SF-PC5000 also features improved installation performance for uneven surfaces, allowing for reduced pressing time. With these features, the SF-PC5000 provides more effective processability compared to the conventional SF-PC1000 and the shielding films created by silver paste printing method.

## Future prospects

While electric equipment is getting more compact and multi-functional, the internal circuitry needs to be more multi-functional and the signal transmission speed needed to become faster. At the same time, noise suppression has become an integral part in circuit design, and shielding materials are providing additional features such as a thinner design and increased flexibility as well as the excellent shielding characteristics. As well as the superb shielding characteristics, the SF-PC5000 features high sliding performance in its ultra-thin body so as to meet the demands for slide style cellular phones. To meet the demands for the advanced electric equipment, we will continue to contribute to the development of the electric equipment industry with conductive multi-functional products.

## TATSUTA SYSTEM ELECTRONICS CO., LTD.

3-1-2 Chome Iwata-cho, Higashi-Osaka City, Osaka 578-8585, Japan  
Tel: +81-6-6721-3321 Fax: +81-6-6721-3097

<http://www.tatsuta.com> Email: [support@tatsuta.com](mailto:support@tatsuta.com)